

Ambient Light Sensor, RoHS Compliant, Released for Lead (Pb)-free Solder Process, AEC-Q101 Released

Description

TEMT6000X01 ambient light sensor plays a key role in power savings strategies by controlling LCD display intensity and keypad backlighting of mobile devices and in industrial on/off-lighting operation. It is sensitive to visible light much like the human eye and has peak sensitivity at 570 nm. TEMT6000X01 has analog output and is packaged in a small surface mount package.

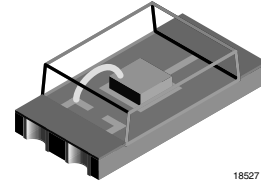

18527

Features

- Product designed and qualified acc. AEC-Q101 for the automotive market
- High sensitivity: $I_{PCE} = 50 \mu A$ ($E_V = 100 \text{ lx}$)
- Adapted to human eye responsivity
- Wide angle of half sensitivity: $\varphi = \pm 60^\circ$
- Surface mount package
- Dimensions: L 4 mm x W 2 mm x H 1.05 mm
- Tape and reel: 3000 pcs/reel
- Minimum order quantity: MOQ = 3000 pcs
- Lead (Pb)-free soldering released
- Lead (Pb)-free component in accordance with RoHS 2002/95/EC and WEEE 2002/96/EC



Applications

Ambient light sensor for control of display backlight dimming in LCD displays and keypad backlighting of mobile devices and in industrial on/off-lighting operation.

- Automotive sensors
- Mobile phones
- Notebook computers
- PDA's
- Cameras
- Dashboards

Absolute Maximum Ratings

$T_{amb} = 25^\circ C$, unless otherwise specified

Parameter	Test condition	Symbol	Value	Unit
Collector emitter voltage		V_{CEO}	6	V
Emitter collector voltage		V_{ECO}	1.5	V
Collector current		I_C	20	mA
Total power dissipation	$T_{amb} \leq 55^\circ C$	P_V	100	mW
Junction temperature		T_j	100	$^\circ C$
Operating temperature range		T_{amb}	- 40 to + 100	$^\circ C$
Storage temperature range		T_{stg}	- 40 to + 100	$^\circ C$
Soldering temperature	Reflow profile figure 7	T_{sd}	260	$^\circ C$
Thermal resistance junction/ambient		R_{thJA}	450	K/W

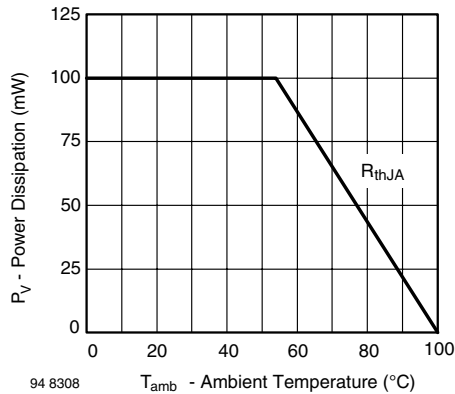

Figure 1. Power Dissipation vs. Ambient Temperature

Basic Characteristics

$T_{amb} = 25\text{ }^{\circ}\text{C}$, unless otherwise specified

Parameter	Test condition	Symbol	Min	Typ.	Max	Unit
Collector emitter breakdown voltage	$I_C = 0.1\text{ mA}$	V_{CEO}	6			V
Collector dark current	$V_{CE} = 5\text{ V}$, $E = 0$	I_{CEO}		3	50	nA
Collector-emitter capacitance	$V_{CE} = 0\text{ V}$, $f = 1\text{ MHz}$, $E = 0$	C_{CEO}		16		pF
Collector light current	$E_v = 20\text{ lx}$, CIE illuminant A, $V_{CE} = 5\text{ V}$	I_{PCE}	3.5	10	16	μA
	$E_v = 100\text{ lx}$, CIE illuminant A, $V_{CE} = 5\text{ V}$	I_{PCE}		50		μA
Temperature coefficient of I_{PCE}	CIE illuminant A	TK_{IPCE}		1.18		%/K
	LED, white	TK_{IPCE}		0.9		%/K
Angle of half sensitivity		ϕ		± 60		deg
Wavelength of peak sensitivity		λ_p		570		nm
Range of spectral bandwidth		$\lambda_{0.1}$		360 to 970		nm
Collector emitter saturation voltage	$E_v = 20\text{ lx}$, CIE illuminant A, $I_{PCE} = 1.2\text{ }\mu\text{A}$	V_{CEsat}		0.1		V

Typical Characteristics

$T_{amb} = 25\text{ }^{\circ}\text{C}$, unless otherwise specified

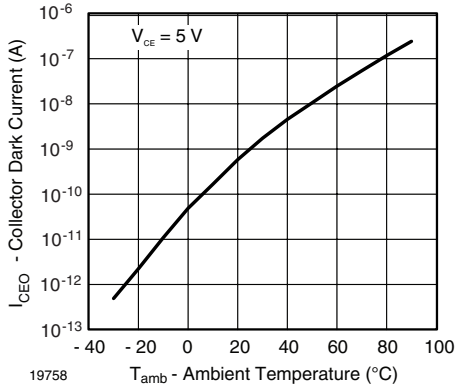

Figure 2. Collector Dark Current vs. Ambient Temperature

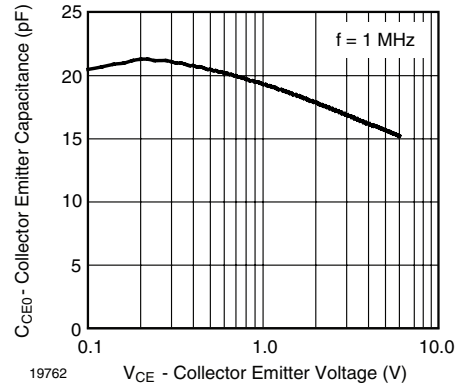

Figure 5. Collector Emitter Capacitance vs. Collector Emitter Voltage

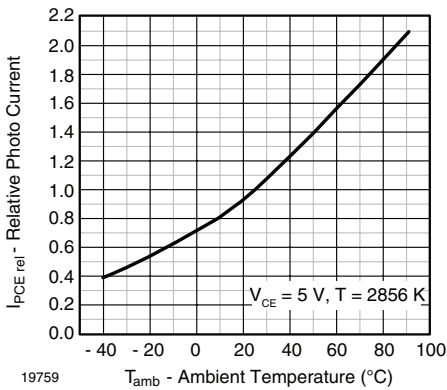

Figure 3. Relative Photo Current vs. Ambient Temperature

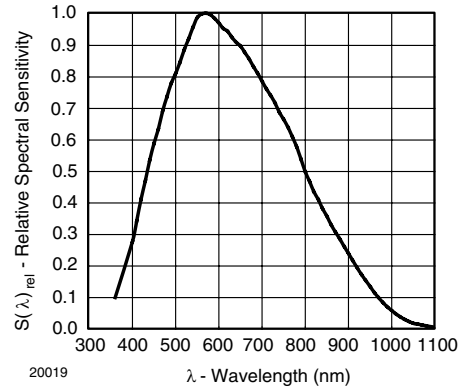

Figure 6. Relative Spectral Sensitivity vs. Wavelength

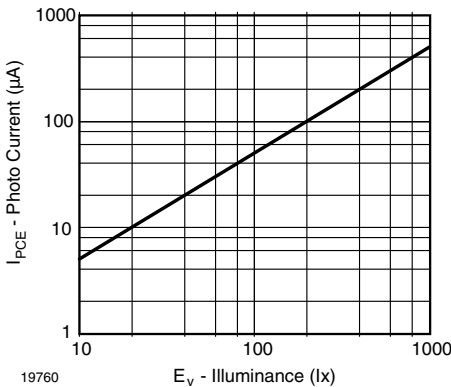

Figure 4. Photo Current vs. Illuminance

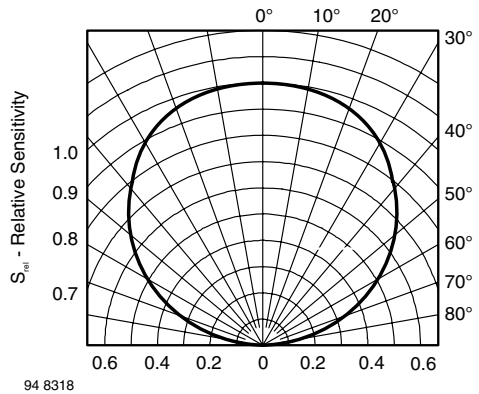

Figure 7. Relative Radiant Sensitivity vs. Angular Displacement

Reflow Solder Profiles

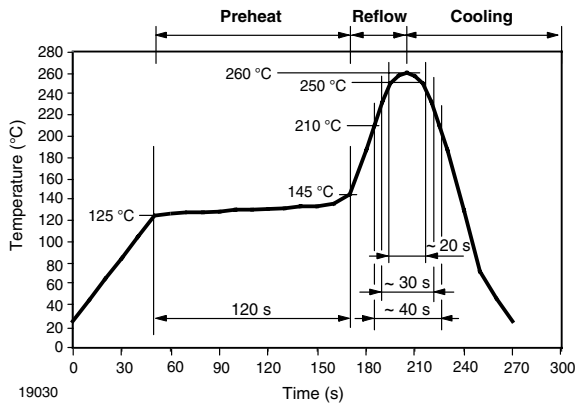

Figure 8. Tin (Sn) Reflow Solder Profile (Pb-free)

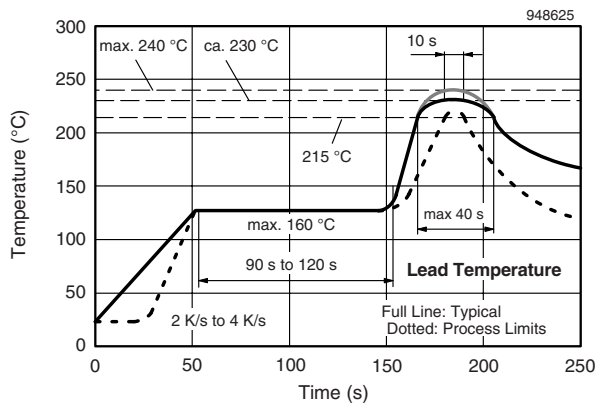

Figure 9. Lead Tin (SnPb) Reflow Solder Profile

Drypack

Devices are packed in moisture barrier bags (MBB) to prevent the products from moisture absorption during transportation and storage. Each bag contains a desiccant.

Floor Life

Floor life (time between soldering and removing from MBB) must not exceed the time indicated in J-STD-020. TEMT6000X01 is released for:

Moisture sensitivity level 4, according to JEDEC, J-STD-020

Floor life: 72 h

Conditions: $T_{amb} < 30\text{ }^{\circ}\text{C}$, $\text{RH} < 60\%$

Drying

In case of moisture absorption devices should be baked before soldering. Conditions see J-STD-020 or label. Devices taped on reel dry using recommended conditions 192 h at $40\text{ }^{\circ}\text{C}$ (+ $5\text{ }^{\circ}\text{C}$), $\text{RH} < 5\%$.

Package Dimensions in millimeters

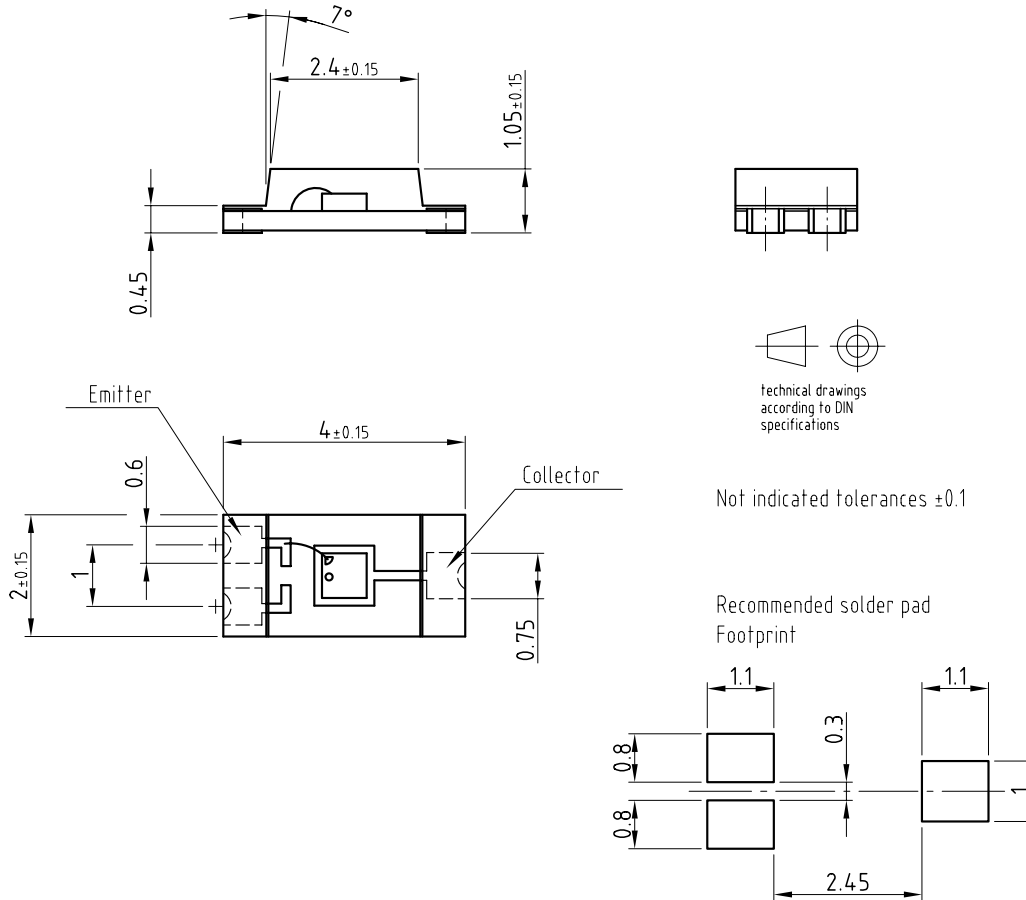

Drawing-No.: 6.541-5053.01-4
 Issue: 3; 27.04.07
 18464

Tape and reel packing: 3000 pcs/reel
 Minimum order quantity: 3000 pcs

Ozone Depleting Substances Policy Statement

It is the policy of Vishay Semiconductor GmbH to

1. Meet all present and future national and international statutory requirements.
2. Regularly and continuously improve the performance of our products, processes, distribution and operating systems with respect to their impact on the health and safety of our employees and the public, as well as their impact on the environment.

It is particular concern to control or eliminate releases of those substances into the atmosphere which are known as ozone depleting substances (ODSs).

The Montreal Protocol (1987) and its London Amendments (1990) intend to severely restrict the use of ODSs and forbid their use within the next ten years. Various national and international initiatives are pressing for an earlier ban on these substances.

Vishay Semiconductor GmbH has been able to use its policy of continuous improvements to eliminate the use of ODSs listed in the following documents.

1. Annex A, B and list of transitional substances of the Montreal Protocol and the London Amendments respectively
2. Class I and II ozone depleting substances in the Clean Air Act Amendments of 1990 by the Environmental Protection Agency (EPA) in the USA
3. Council Decision 88/540/EEC and 91/690/EEC Annex A, B and C (transitional substances) respectively.

Vishay Semiconductor GmbH can certify that our semiconductors are not manufactured with ozone depleting substances and do not contain such substances.

We reserve the right to make changes to improve technical design
and may do so without further notice.

Parameters can vary in different applications. All operating parameters must be validated for each customer application by the customer. Should the buyer use Vishay Semiconductors products for any unintended or unauthorized application, the buyer shall indemnify Vishay Semiconductors against all claims, costs, damages, and expenses, arising out of, directly or indirectly, any claim of personal damage, injury or death associated with such unintended or unauthorized use.

Vishay Semiconductor GmbH, P.O.B. 3535, D-74025 Heilbronn, Germany



Disclaimer

All product specifications and data are subject to change without notice.

Vishay Intertechnology, Inc., its affiliates, agents, and employees, and all persons acting on its or their behalf (collectively, "Vishay"), disclaim any and all liability for any errors, inaccuracies or incompleteness contained herein or in any other disclosure relating to any product.

Vishay disclaims any and all liability arising out of the use or application of any product described herein or of any information provided herein to the maximum extent permitted by law. The product specifications do not expand or otherwise modify Vishay's terms and conditions of purchase, including but not limited to the warranty expressed therein, which apply to these products.

No license, express or implied, by estoppel or otherwise, to any intellectual property rights is granted by this document or by any conduct of Vishay.

The products shown herein are not designed for use in medical, life-saving, or life-sustaining applications unless otherwise expressly indicated. Customers using or selling Vishay products not expressly indicated for use in such applications do so entirely at their own risk and agree to fully indemnify Vishay for any damages arising or resulting from such use or sale. Please contact authorized Vishay personnel to obtain written terms and conditions regarding products designed for such applications.

Product names and markings noted herein may be trademarks of their respective owners.

Mouser Electronics

Authorized Distributor

Click to View Pricing, Inventory, Delivery & Lifecycle Information:

[Vishay:](#)

[TEMT6000X01](#)