



ENERGY RECOVERY PRODUCTS™



**EBR010** 6-10 W  
**EBR015** 11-15 W  
**EBR020** 16-21 W

## Constant Current LED Drivers with Deep TRIAC/ELV Dimming (1 - 100%) and with Fast Startup Time





Input Voltage	Max. Output Power	Output Voltage	Output Current	Efficiency	Max. Case Temperature	THD	Power Factor	Dimming Method	Dimming Range	Startup Time
120 or 220/230/240 Vac nominal	21 W	16 to 42 Vdc	200 to 700 mA CC	≥ 87%	90°C (measured at the hot spot)	< 20%	> 0.9	Forward-Phase, Reverse-Phase	1 - 100% (% of Iout)	150 ms typical

CC: Constant Current

### PRODUCT DESCRIPTION

The EBR series of LED drivers is ideally suited for recessed lighting in commercial, architectural and residential LED lighting applications. These devices are compatible with most industry standard phase-cut wall-based dimmers, both forward-phase (leading-edge) and reverse-phase (trailing-edge), and offer deep dimming from 100% down to 1%.

### FEATURES

- 120 Vac or 220/230/240 Vac nominal input
- Compatible with industry standard phase-cut dimmers: TRIAC (forward-phase or leading-edge) and ELV (reverse-phase or trailing-edge)
- Lifetime: 112,000 hours at 70°C case hot spot temperature (58°C ambient temperature) for EBR010U-0250-42
- Low acoustic noise of 20 dBA
- Protections: output open load, over-current and short-circuit (hiccup), and over-temperature with auto recovery
- Conducted and radiated EMI: Compliant with FCC CFR Title 47 Part 15 Class B for 120 Vac and EN55015 (CISPR 15) for 220/230/240 Vac
- Enables ENERGY STAR® and DLC (DesignLight Consortium®) luminaire compliance
- IP20-rated case with silicon-based potting
- 94V-0 flammability rating (5VA available upon request)
- 90°C maximum case hot spot temperature
- Class 2 power supply
- Double-insulated power supply between input and output (class II) 
- Worldwide Safety approvals    

### APPLICATIONS

- Recessed lighting (downlights)
- Commercial & Residential lighting
- Architectural lighting

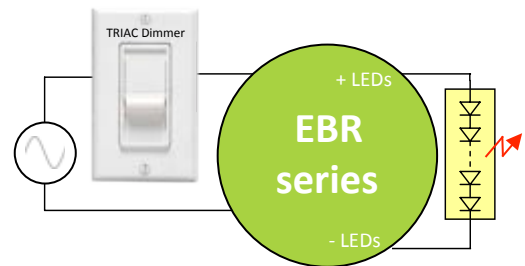

APPLICATION DIAGRAM



**PLASTIC CASE:**  
Diameter: 58 mm (2.28 in)  
Height: 31.7 mm (1.25 in)

#### Neutral:

- White: 120 Vac
  - Blue: 220/230/240 Vac
- Line:**
- Black: 120 Vac
  - Brown: 220/230/240 Vac

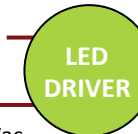

WIRING DIAGRAM



ENERGY RECOVERY PRODUCTS™



**EBR010** 6-10 W  
**EBR015** 11-15 W  
**EBR020** 16-21 W

## Constant Current LED Drivers with Deep TRIAC/ELV Dimming (1 - 100%) and with Fast Startup Time

### 1 - INPUT SPECIFICATION (@25°C ambient temperature)

	Units	Minimum	Typical	Maximum	Notes
<b>Input Voltage Range (Vin)</b> -EBR010/015/020U -EBR010/015/020E	Vac	90 180	120 230	132 264	The rated output current for each model is achieved at Vin ≥ 115 Vac for EBRxxU and at Vin ≥ 209 Vac for EBRxxE.
<b>Input Frequency Range</b> -EBR010/015/020U -EBR010/015/020E	Hz	57 47	60 50	63 53	
<b>Power Factor (PF)</b>		0.9	> 0.9		At nominal input voltage and with nominal LED voltage
<b>Input Current</b>	A	-	-	0.27 A @ 120 Vac 0.20 A @ 230 Vac	
<b>Inrush Current</b>	A			10 A peak	At any point on the sine wave and 25°C
<b>Leakage Current</b>	µA			250 µA @ 120 Vac 500 µA @ 230 Vac	Measured per IEC60950-1
<b>Input Harmonics</b>	Complies with IEC61000-3-2 for Class C equipment				
<b>Total Harmonics Distortion (THD)</b>				20%	<ul style="list-style-type: none"> <li>At nominal input voltage and nominal LED voltage</li> <li>Complies with DLC (DesignLight Consortium) technical requirements</li> </ul>
<b>Efficiency</b>		-	85%	-	<ul style="list-style-type: none"> <li>Measured with nominal input voltage, a full sinusoidal wave form and without dimmer connected.</li> <li>Models with power ≤10W have an efficiency of ≥ 83%.</li> </ul>
<b>Isolation</b>	Meets UL60950-1 for class II reinforced/double insulation power supply <input type="checkbox"/>				

### 2 - OUTPUT SPECIFICATION (@25°C ambient temperature)

	Units	Minimum	Typical	Maximum	Notes
<b>Output Voltage (Vout)</b>	Vdc	16		42	See ordering information for details
<b>Output Current (Iout)</b>	mA	200		700	<ul style="list-style-type: none"> <li>See ordering information for details</li> <li>The rated output current for each model is achieved at Vin ≥ 115 Vac for EBRxxU and at Vin ≥ 209 Vac for EBRxxE.</li> </ul>
<b>Output Current Regulation</b>	%	-5	±2.5	5	<ul style="list-style-type: none"> <li>At nominal AC line voltage</li> <li>Includes load and current set point variations</li> </ul>
<b>Output Current Overshoot</b>	%	-	-	10	The driver does not operate outside of the regulation requirements for more than 2 s during power on with nominal LED load and without dimmer.
<b>Ripple Current</b>	%	< 25% of rated output current for each model			<ul style="list-style-type: none"> <li>≤ 25% of the rated output current for all models with Vout max ≥ 42 V</li> <li>≤ 30% of the rated output current for all models with Vout max ≤ 36 V</li> <li>At nominal LED voltage and nominal input voltage without dimming</li> <li>In accordance with the IES Lighting Handbook, 9th edition</li> </ul>
<b>Dimming Range (% of Iout)</b>		1%		100%	The dimming range will be dependent on each specific dimmer.
<b>Start-up Time</b>	ms		150		•With nominal LED voltage and without dimmer attached
			300		•With nominal LED voltage, with an approved dimmer attached (see list of approved dimmers in page 5) and at the full dimming conduction angle



ENERGY RECOVERY PRODUCTS™



**EBR010** 6-10 W  
**EBR015** 11-15 W  
**EBR020** 16-21 W

## Constant Current LED Drivers with Deep TRIAC/ELV Dimming (1 - 100%) and with Fast Startup Time

### 3 - ENVIRONMENTAL CONDITIONS

	Units	Minimum	Typical	Maximum	Notes
<b>Operating Case Temperature (Tc)</b>	°C	-30		+90	Case temperature measured at the hot spot •tc (see label in page 9)
<b>Storage Temperature</b>	°C	-40		+85	
<b>Humidity</b>	%	5	-	95	Non-condensing
<b>Cooling</b>	Convection cooled				
<b>Acoustic Noise</b>	dBa			20	Measured at a distance of 1 meter, without and with approved dimmers
<b>Mechanical Shock Protection</b>	per EN60068-2-27				
<b>Vibration Protection</b>	per EN60068-2-6 & EN60068-2-64				
<b>MTBF</b>	> 300,000 hours when operated at nominal input and output conditions, and at Tc ≤ 70°C				
<b>Lifetime (see graphs "Lifetime vs. Case and Ambient Temperature" in section 6)</b>	<ul style="list-style-type: none"> <li>•112,000 hours at Tc = 70°C (Tambient = 58.1°C) for EBR010U-0250-42 (10.5 W)</li> <li>•84,000 hours at Tc = 70°C (Tambient = 58.5°C) for EBR020U-0500-42 (21 W)</li> <li>•Measured at the hot spot (see hot spot •tc on label in page 9)</li> </ul>				

### 4 - EMC COMPLIANCE AND SAFETY APPROVALS

EMC Compliance			
<b>Conducted and Radiated EMI</b>	FCC CFR Title 47 Part 15 Class B for 120 Vac and EN55015 (CISPR 15) for 220/230/240 Vac		
<b>Harmonic Current Emissions</b>	IEC61000-3-2	For Class C equipment	
<b>Voltage Fluctuations &amp; Flicker</b>	IEC61000-3-3		
<b>Immunity Compliance</b>	<b>ESD (Electrostatic Discharge)</b>	IEC61000-4-2	6 kV contact discharge, 8 kV air discharge, level 3
	<b>RF Electromagnetic Field Susceptibility</b>	IEC61000-4-3	3 V/m, 80 - 1000 MHz, 80% modulated at a distance of 3 meters
	<b>Electrical Fast Transient</b>	IEC61000-4-4	± 2 kV on AC power port for 1 minute, ±1 kV on signal/control lines
	<b>Surge</b>	IEC61000-4-5	± 1 kV line to line (differential mode) / ± 2 kV line to common mode ground (tested to secondary ground) on AC power port, ±0.5 kV for outdoor cables
	<b>Conducted RF Disturbances</b>	IEC61000-4-6	3V, 0.15-80 MHz, 80% modulated
	<b>Voltage Dips</b>	IEC61000-4-11	>95% dip, 0.5 period; 30% dip, 25 periods; 95% reduction, 250 periods
<b>Transient Protection</b>	<b>Ring Wave</b>	ANSI/IEEE c62.41.1-2002 & c62.41.2-2002 category A, 2.5 kV ring wave	

Safety Agency Approvals		
<b>UL</b>	UL8750 recognized	UL60950-1 recognized
<b>cUL</b>	CSA C22.2 60950-1	

Safety					
	Units	Minimum	Typical	Maximum	Notes
<b>Hi Pot (High Potential) or Dielectric Voltage Withstand</b>	Vdc	4242			<ul style="list-style-type: none"> <li>•Insulation between the input (AC line and Neutral) and the output</li> <li>•Tested at the RMS voltage equivalent of 3000 Vac</li> </ul>



ENERGY RECOVERY PRODUCTS™



**EBR010** 6-10 W  
**EBR015** 11-15 W  
**EBR020** 16-21 W

## Constant Current LED Drivers with Deep TRIAC/ELV Dimming (1 - 100%) and with Fast Startup Time

### ■ 5 - PROTECTION FEATURES

#### **Under-Voltage (Brownout)**

The EBR series provides protection circuitry such that an application of an input voltage below the minimum stated in paragraph 1 (Input Specification) shall not cause damage to the driver.

#### **Short Circuit**

The EBR series is protected against short-circuit such that a short from any output to return shall not result in a fire hazard or shock hazard. The driver shall hiccup as a result of a short circuit or over current fault. Removal of the fault will return the driver to within normal operation. The driver shall recover, with no damage, from a short across the output for an indefinite period of time.

#### **Internal Over temperature Protection**

The EBR series incorporates circuitry that prevents internal damage due to an over temperature condition. An over temperature condition may be a result of an excessive ambient temperature or as a result of an internal failure. When the over temperature condition is removed, the driver shall automatically recover.

#### **Output Open Load**

When the LED load is removed, the output voltage of the EBR series is limited to 1.3 times the maximum output voltage of each model.



ENERGY RECOVERY PRODUCTS™



**EBR010** 6-10 W  
**EBR015** 11-15 W  
**EBR020** 16-21 W

## Constant Current LED Drivers with Deep TRIAC/ELV Dimming (1 - 100%) and with Fast Startup Time

### 6 - PREDICTED LIFETIME VERSUS CASE AND AMBIENT TEMPERATURE

Lifetime is defined by the measurement of the temperatures of all the electrolytic capacitors whose failure would affect light output under the nominal LED load and worst case AC line voltage. The graphs in figure 1 are determined by the electrolytic capacitor with the shortest lifetime, among all electrolytic capacitors. It represents a worst case scenario in which the LED driver is powered 24 hours/day, 7 days/week. The lifetime of an electrolytic capacitor is measured when any of the following changes in performance are observed:

- 1) Capacitance changes more than 20% of initial value
- 2) Dissipation Factor ( $\tan \delta$ ): 150% or less of initial specified value
- 3) Equivalent Series Resistance (ESR): 150% or less of initial specified value
- 4) Leakage current: less of initial specified value

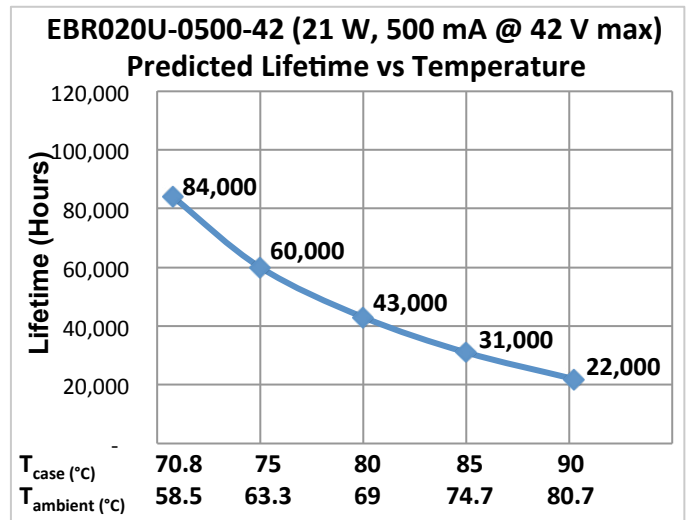
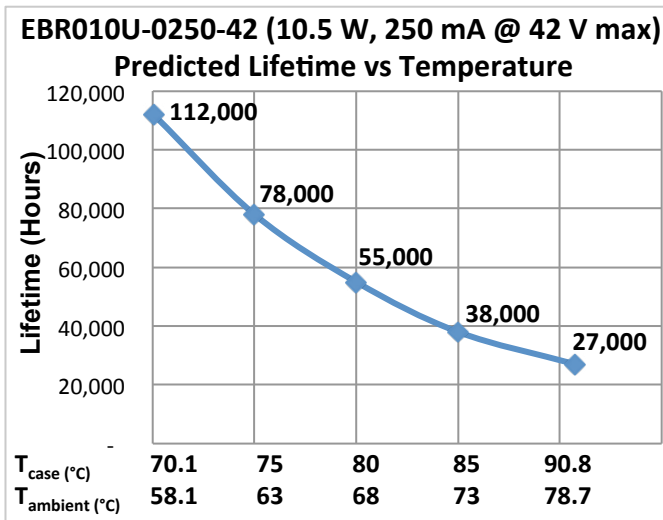

Figure 1

#### Notes:

- The ambient temperature  $T_{ambient}$  and the differential between  $T_{ambient}$  and  $T_{case}$  mentioned in the above graphs are relevant only as long as both the driver and the light fixture are exposed to the same ambient room temperature. If the LED driver is housed in an enclosure or covered by insulation material, then the ambient room temperature is no longer valid. In this situation, please refer only to the case temperature  $T_{case}$ .
- It should be noted the graph "Lifetime vs. Ambient Temperature" may have an error induced in the final application if the mounting has restricted convection flow around the case. For applications where this is evident, the actual case temperature measured at the  $T_c$  point in the application should be used for reliability calculations.



## Constant Current LED Drivers with Deep TRIAC/ELV Dimming (1 - 100%) and with Fast Startup Time

### 7 - PHASE-CUT DIMMING

Dimming of the driver is possible with standard TRIAC-based incandescent dimmers that chop the AC voltage as shown in Figure 2, or with ELV dimmers. During the rapid rise time of the AC voltage when the dimmer turns on, the driver does not generate any voltage or current oscillations, and inrush current is controlled. During the on-time of the AC input, the driver regulates the output current based upon the conduction angle. The RMS value of the driver output current is proportional to the on-time of the AC input voltage. When operating with an incandescent dimmer, the RMS output current varies depending upon the conduction angle and RMS value of the applied AC input voltage. Figure 3 shows the typical output current versus conduction angle at nominal input voltage.

When using low power EBR models (specifically < 10 W) with a reverse-phase or forward-phase dimmer, always make sure the minimum required load is applied to the dimmer. Check the dimmer documentation for minimum load requirements.

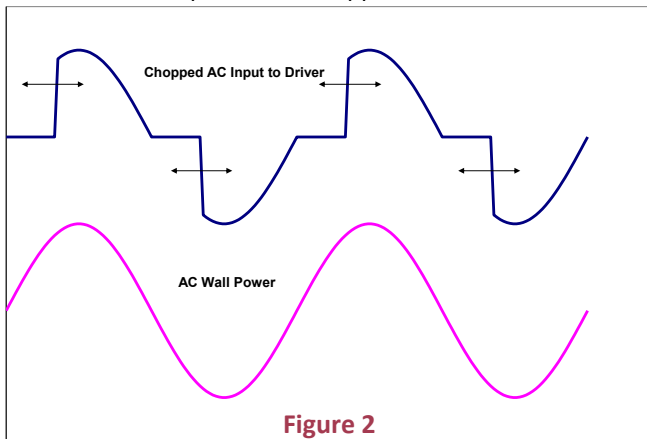

Figure 2

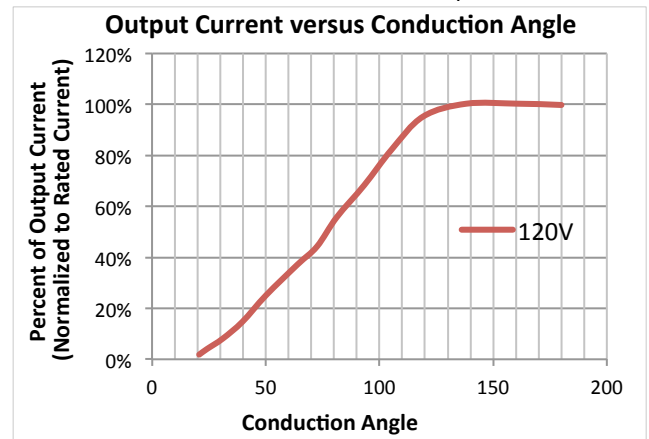

Figure 3

### 8 - COMPATIBLE PHASE-CUT DIMMERS & DIMMING RANGE

The dimming range represents typical values and may vary for the same dimmer model number when installed.

#### Model EBR020U-0500-42 (21 W, 500 mA @ 42 V max)

Dimmer List			Dimming Range (% Iout)		Flicker Result
Manufacturer	Series	Model Number	Max	Min	
Cooper	Aspire	9573WS	100	24.2	PASS
Cooper	Devine	DI06P-A-K	100	9.5	PASS
Legrand	Paddle	ADPD453L-W2	100	22	PASS
Leviton	Illuminatech	IP106	100	4.1	PASS
Leviton	Sureslide	6631-LW	100	0.6	PASS
Leviton	Sureslide	6613-PL	100	7.1	PASS
Lutron	Skylark	S-603PG (1)	81	6	PASS
Lutron	Diva	DVCL-153PR	95.4	1.2	PASS
Lutron	Ariadni	AY-600P-AL	100	10.7	PASS
Lutron	Maestro	MRF2-600M-WH	96.2	3	PASS
Lutron	Skylark	S-600P-AL	98.2	4.5	PASS
Lutron	Diva	DV-600P-WH	98.2	5.8	PASS
Lutron	Nova	N-600	100	5.6	PASS
Lutron	Skylark	SLV-600-WH	100	8	PASS
Lutron	Glyder	GLV-600-WH	100	3.8	PASS

Note (1): All models exhibit limited range with this dimmer

Dimming compatibility charts are available for each model in the EBR series. Please contact your sales representative or send an email to: [SaveEnergy@ERPPowerLLC.com](mailto:SaveEnergy@ERPPowerLLC.com).



# Constant Current LED Drivers with Deep TRIAC/ELV Dimming (1 - 100%) and with Fast Startup Time

## 9 - MECHANICAL DETAILS

**Packaging Options:** Plastic case

**I/O Connections:** Flying leads, 18 AWG on power leads, 152 mm (6 in) long, 105°C rated, stranded, stripped by approximately 9.5mm, and tinned. All the wires, on both input and output, have a 300 V insulation rating.

**Ingress Protection:** IP20 rated. Only models in the EBR020 (16-20 W power range) have potting.

**Flammability Rating:** UL94 V-0 (5VA available upon request. Please contact your sales representative or send an email to: [SaveEnergy@ERPPowerLLC.com](mailto:SaveEnergy@ERPPowerLLC.com)).

**Mounting Instructions:** The EBR driver case must be secured on a flat surface through the two mounting tabs, shown here below in the case outline drawings.

## 10 - OUTLINE DRAWINGS

**Dimensions:** Diameter: 58 mm (2.6 in), Height: 31.7 mm (1.25 in)

**Volume:** 83.7 cm<sup>3</sup> (5.1 in<sup>3</sup>)

**Weight:** 170.5 g (6 oz)

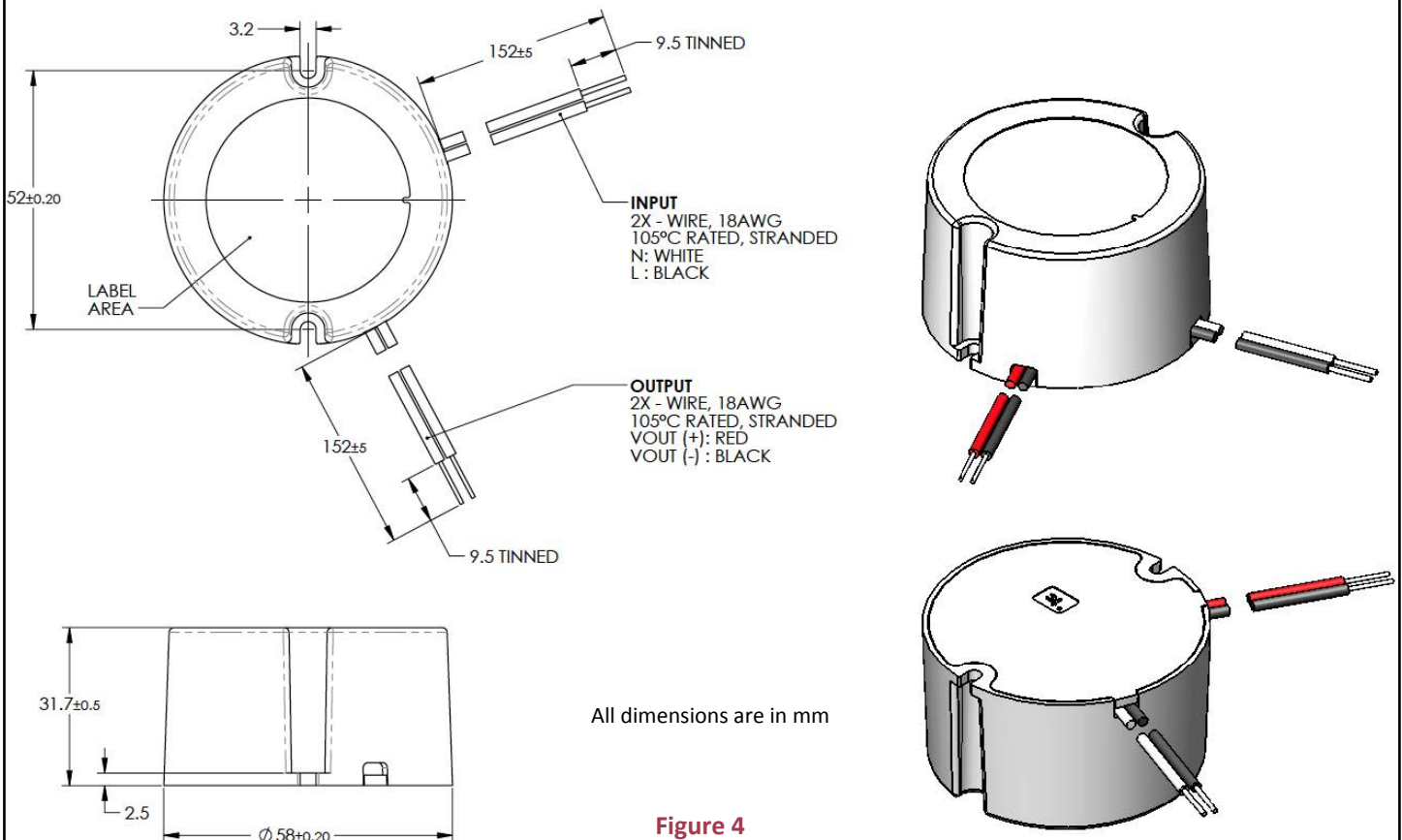

All dimensions are in mm

Figure 4



ENERGY RECOVERY PRODUCTS™



**EBR010** 6-10 W  
**EBR015** 11-15 W  
**EBR020** 16-21 W

## Constant Current LED Drivers with Deep TRIAC/ELV Dimming (1 - 100%) and with Fast Startup Time

### II - ORDERING INFORMATION - MODEL DESCRIPTION

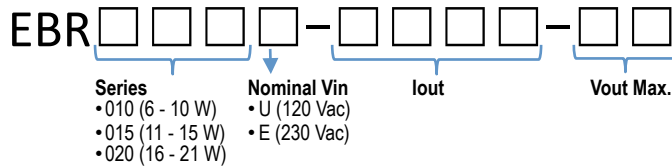

	ERP Part Number	Nominal Input Voltage (Vac)	Iout (mA)	Max Output Power (W)	Vout Min (Vdc)	Vout Nom (Vdc)	Vout Max (Vdc)	No Load Voltage (Vdc)
120 VAC NOMINAL INPUT VOLTAGE	<b>EBR010U: 8 to 10 W</b>							
	EBR010U-0200-42	120	200	8.4	30	37.8	42	50
	EBR010U-0250-42	120	250	10.5	30	37.8	42	50
	EBR010U-0440-24	120	440	10.6	16	21.6	24	31.2
	<b>EBR015U: 11 to 15 W</b>							
	EBR015U-0285-42	120	285	12.0	30	37.8	42	50
	EBR015U-0300-42	120	300	12.6	30	37.8	42	50
	EBR015U-0350-32	120	350	11.2	21	28.8	32	41.6
	EBR015U-0350-42	120	350	14.7	30	37.8	42	50
	EBR015U-0440-36	120	440	15.8	24	32.4	36	46.8
	<b>EBR020U: 16 to 21 W</b>							
	EBR020U-0400-42	120	400	16.8	30	37.8	42	50
	EBR020U-0460-42	120	460	19.3	30	37.8	42	50
	EBR020U-0500-32	120	500	16.0	21	28.8	32	41.6
	EBR020U-0500-37	120	500	18.5	25	32.4	37	46.8
	EBR020U-0500-42	120	500	21.0	30	37.8	42	50
	EBR020U-0700-24	120	700	16.8	16	21.6	24	31.2
	EBR020U-0700-30	120	700	21.0	20	27.0	30	35
230 VAC NOMINAL INPUT	<b>EBR010E: 8 to 10 W</b>							
	EBR010E-0200-42	220/230/240	200	8.4	30	37.8	42	50
	EBR010E-0250-42	220/230/240	250	10.5	30	37.8	42	50
	EBR010E-0440-24	220/230/240	440	10.6	16	21.6	24	31.2
	<b>EBR015E: 11 to 15 W</b>							
	EBR015E-0300-42	220/230/240	300	12.6	30	37.8	42	50
	EBR015E-0350-42	220/230/240	350	14.7	30	37.8	42	50
	EBR015E-0440-36	220/230/240	440	15.8	24	32.4	36	46.8
	<b>EBR020E: 16 to 21 W</b>							
	EBR020E-0400-42	220/230/240	400	16.8	30	37.8	42	50
	EBR020E-0500-37	220/230/240	500	18.5	25	33.3	37	48
	EBR020E-0500-42	220/230/240	500	21.0	30	37.8	42	50
EBR020E-0700-24	220/230/240	700	16.8	16	21.6	24	31.2	

For additional options of output current and output voltage, contact your sales representative or send an email to: [SaveEnergy@ERPPowerLLC.com](mailto:SaveEnergy@ERPPowerLLC.com)





ENERGY RECOVERY PRODUCTS™



**EBR010** 6-10 W  
**EBR015** 11-15 W  
**EBR020** 16-21 W

## Constant Current LED Drivers with Deep TRIAC/ELV Dimming (1 - 100%) and with Fast Startup Time

### I2 - LABELING

The EBR015U-0350-42 (120 Vac) and the EBR020E-0500-42 (220/230/240 Vac) are used in figure 5 as an example to illustrate a typical label.

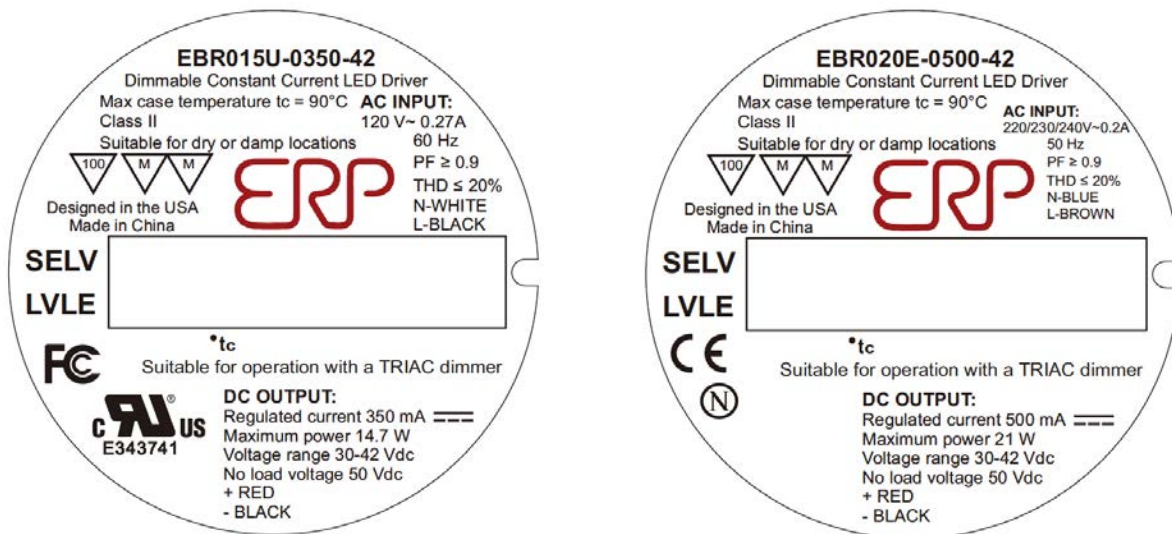

Figure 5

#### USA Headquarters

Tel: +1-805-517-1300  
Fax: +1-805-517-1411  
301 Science Drive, Suite 210  
Moorpark, CA 93021, USA

#### CHINA Operations

Tel: +86-756-6266298  
Fax: +86-756-6266299  
No. 8 Pingdong Road 2  
Zhuhai, Guangdong, China 519060

ERP - Energy Recovery Products (ERP Power, LLC) - reserves the right to make changes without further notice to any products herein. ERP makes no warranty, representation or guarantee regarding the suitability of its products for any particular purpose, nor does ERP assume any liability arising out of the application or use of any product or circuit, and specifically disclaims any and all liability, including without limitation special, consequential or incidental damages. "Typical" parameters which may be provided in ERP data sheets and/or specifications can and do vary in different applications and actual performance may vary over time. All operating parameters, including "Typicals" must be validated for each customer application by customer's technical experts. ERP does not convey any license under its patent rights nor the rights of others. ERP products are not designed, intended, or authorized for use as components in systems intended for surgical implant into the body, or other applications intended to support or sustain life, or for any other application in which the failure of the ERP product could create a situation where personal injury or death may occur. Should Buyer purchase or use ERP products for any such unintended or unauthorized application, Buyer shall indemnify and hold ERP and its officers, employees, subsidiaries, affiliates, and distributors harmless against all claims, costs, damages, and expenses, and reasonable attorney fees arising out of, directly or indirectly, any claim of personal injury or death associated with such unintended or unauthorized use, even if such claim alleges that ERP was negligent regarding the design or manufacture of the part. ERP is an Equal Opportunity/Affirmative Action Employer. This literature is subject to all applicable copyright laws and is not for resale in any manner.

# Mouser Electronics

Authorized Distributor

Click to View Pricing, Inventory, Delivery & Lifecycle Information:

## [ERP \(Energy Recovery Products\):](#)

[EBR015U-0350-42](#) [EBR015U-0440-36](#) [EBR020U-0500-37](#) [EBR020E-0500-42](#) [EBR020U-0700-24](#) [EBR010E-0200-42](#) [EBR015U-0300-42](#) [EBR020U-0500-32](#) [EBR015E-0440-36](#) [EBR020U-0400-42](#) [EBR020U-0700-30](#) [EBR010U-0250-42](#) [EBR010U-0200-42](#) [EBR020U-0460-42](#) [EBR020U-0500-42](#) [EBR015E-0350-42](#) [EBR010U-0440-24](#) [EBR015U-0350-32](#) [EBR010E-0250-42](#)