

# MF10 Universal Monolithic Dual Switched Capacitor Filter

## General Description

The MF10 consists of 2 independent and extremely easy to use, general purpose CMOS active filter building blocks. Each block, together with an external clock and 3 to 4 resistors, can produce various 2nd order functions. Each building block has 3 output pins. One of the outputs can be configured to perform either an allpass, highpass or a notch function; the remaining 2 output pins perform lowpass and bandpass functions. The center frequency of the lowpass and bandpass 2nd order functions can be either directly dependent on the clock frequency, or they can depend on both clock frequency and external resistor ratios. The center frequency of the notch and allpass functions is directly dependent on the clock frequency, while the highpass center frequency depends on both resistor ratio and clock. Up to 4th order functions can be performed by cascading the two 2nd order building blocks of the MF10; higher than 4th order functions can be obtained by cascading MF10 packages.

Any of the classical filter configurations (such as Butterworth, Bessel, Cauer and Chebyshev) can be formed.

For pin-compatible device with improved performance refer to LMF100 datasheet.

## Features

- Easy to use
- Clock to center frequency ratio accuracy  $\pm 0.6\%$
- Filter cutoff frequency stability directly dependent on external clock quality
- Low sensitivity to external component variation
- Separate highpass (or notch or allpass), bandpass, lowpass outputs
- $f_0 \times Q$  range up to 200 kHz
- Operation up to 30 kHz
- 20-pin 0.3" wide Dual-In-Line package
- 20-pin Surface Mount (SO) wide-body package

## System Block Diagram

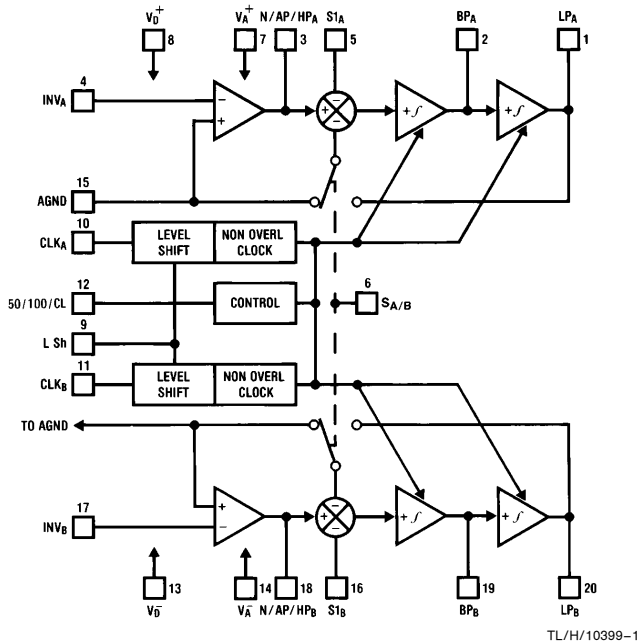

## Connection Diagram

Surface Mount and Dual-In-Line Package

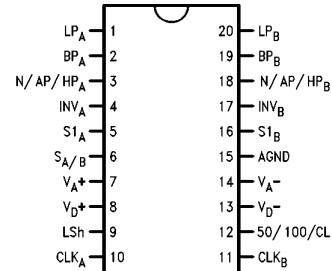

TL/H/10399-4

Top View

- Order Number MF10AJ or MF10CCJ  
See NS Package Number J20A
- Order Number MF10ACWM or MF10CCWM  
See NS Package Number M20B
- Order Number MF10ACN or MF10CCN  
See NS Package Number N20A

MF10 Universal Monolithic Dual Switched Capacitor Filter

## Absolute Maximum Ratings (Note 1)

If Military/Aerospace specified devices are required, please contact the National Semiconductor Sales Office/Distributors for availability and specifications.

Supply Voltage ( $V^+ - V^-$ )	14V
Voltage at Any Pin	$V^+ + 0.3V$ $V^- - 0.3V$
Input Current at Any Pin (Note 2)	5 mA
Package Input Current (Note 2)	20 mA
Power Dissipation (Note 3)	500 mW
Storage Temperature	150°C
ESD Susceptibility (Note 11)	2000V

## Soldering Information

N Package: 10 sec.	260°C
J Package: 10 sec.	300°C
SO Package: Vapor Phase (60 Sec.)	215°C
Infrared (15 Sec.)	220°C

See AN-450 "Surface Mounting Methods and Their Effect on Product Reliability" (Appendix D) for other methods of soldering surface mount devices.

## Operating Ratings (Note 1)

Temperature Range	$T_{MIN} \leq T_A \leq T_{MAX}$
MF10ACN, MF10CCN	$0^\circ\text{C} \leq T_A \leq 70^\circ\text{C}$
MF10CCWM, MF10ACWM	$0^\circ\text{C} \leq T_A \leq 70^\circ\text{C}$
MF10CCJ	$-40^\circ\text{C} \leq T_A \leq 85^\circ\text{C}$
MF10AJ	$-55^\circ\text{C} \leq T_A \leq 125^\circ\text{C}$

**Electrical Characteristics**  $V^+ = +5.00V$  and  $V^- = -5.00V$  unless otherwise specified. **Boldface limits apply for  $T_{MIN}$  to  $T_{MAX}$** ; all other limits  $T_A = T_J = 25^\circ\text{C}$ .

Symbol	Parameter		Conditions		MF10ACN, MF10CCN, MF10ACWM, MF10CCWM			MF10CCJ, MF10AJ			Units	
					Typical (Note 8)	Tested Limit (Note 9)	Design Limit (Note 10)	Typical (Note 8)	Tested Limit (Note 9)	Design Limit (Note 10)		
$V^+ - V^-$	Supply Voltage	Min					<b>9</b>			<b>9</b>	V	
		Max					<b>14</b>			<b>14</b>	V	
$I_S$	Maximum Supply Current	Clock Applied to Pins 10 & 11 No Input Signal		8	12	<b>12</b>	8	<b>12</b>			mA	
$f_O$	Center Frequency Range	Min	$f_O \times Q < 200 \text{ kHz}$		0.1		<b>0.2</b>	0.1		<b>0.2</b>	Hz	
		Max			30		<b>20</b>	30		<b>20</b>	kHz	
$f_{CLK}$	Clock Frequency Range	Min			5.0		<b>10</b>	5.0		<b>10</b>	Hz	
		Max			1.5		<b>1.0</b>	1.5		<b>1.0</b>	MHz	
$f_{CLK}/f_O$	50:1 Clock to Center Frequency Ratio Deviation	MF10A MF10C	Q = 10 Mode 1	$V_{pin12} = 5V$ $f_{CLK} = 250 \text{ kHz}$	$\pm 0.2$	$\pm 0.6$	$\pm \mathbf{0.6}$	$\pm 0.2$	$\pm \mathbf{1.0}$		%	
					$\pm 0.2$	$\pm 1.5$	$\pm \mathbf{1.5}$	$\pm 0.2$	$\pm \mathbf{1.5}$		%	
$f_{CLK}/f_O$	100:1 Clock to Center Frequency Ratio Deviation	MF10A MF10C	Q = 10 Mode 1	$V_{pin12} = 0V$ $f_{CLK} = 500 \text{ kHz}$	$\pm 0.2$	$\pm 0.6$	$\pm \mathbf{0.6}$	$\pm 0.2$	$\pm \mathbf{1.0}$		%	
					$\pm 0.2$	$\pm 1.5$	$\pm \mathbf{1.5}$	$\pm 0.2$	$\pm \mathbf{1.5}$		%	
	Clock Feedthrough	Q = 10 Mode 1		10			10				mV	
	Q Error (MAX) (Note 4)	Q = 10 Mode 1		$V_{pin12} = 5V$ $f_{CLK} = 250 \text{ kHz}$	$\pm 2$	$\pm 6$	$\pm \mathbf{6}$	$\pm 2$	$\pm \mathbf{10}$		%	
					$\pm 2$	$\pm 6$	$\pm \mathbf{6}$	$\pm 2$	$\pm \mathbf{10}$		%	
$H_{OLP}$	DC Lowpass Gain	Mode 1 $R1 = R2 = 10k$		0	$\pm 0.2$	$\pm \mathbf{0.2}$	0	$\pm \mathbf{0.2}$			dB	
$V_{OS1}$	DC Offset Voltage (Note 5)			$\pm 5.0$	$\pm 20$	$\pm \mathbf{20}$	$\pm 5.0$	$\pm \mathbf{20}$			mV	
$V_{OS2}$	DC Offset Voltage (Note 5)	Min	$V_{pin12} = +5V$ $(f_{CLK}/f_O = 50)$	$S_{A/B} = V^+$	$-150$	$-185$	$-\mathbf{185}$	$-150$	$-\mathbf{185}$		mV	
					$-70$			$-70$				
		Max	$V_{pin12} = +5V$ $(f_{CLK}/f_O = 50)$	$S_{A/B} = V^-$	$-70$			$-70$				mV
$V_{OS3}$	DC Offset Voltage (Note 5)	Min	$V_{pin12} = +5V$ $(f_{CLK}/f_O = 50)$	All Modes	$-70$	$-100$	$-\mathbf{100}$	$-70$	$-\mathbf{100}$		mV	
		Max				$-20$	$-\mathbf{20}$		$-\mathbf{20}$			
$V_{OS2}$	DC Offset Voltage (Note 5)		$V_{pin12} = 0V$ $(f_{CLK}/f_O = 100)$	$S_{A/B} = V^+$	$-300$			$-300$			mV	
					$-140$			$-140$				
$V_{OS3}$	DC Offset Voltage (Note 5)		$V_{pin12} = 0V$ $(f_{CLK}/f_O = 100)$	All Modes	$-140$			$-140$			mV	

**Electrical Characteristics** (Continued)  $V^+ = +5.00V$  and  $V^- = -5.00V$  unless otherwise specified.  
**Boldface limits apply for  $T_{MIN}$  to  $T_{MAX}$** ; all other limits  $T_A = T_J = 25^\circ C$ .

Symbol	Parameter	Conditions	MF10ACN, MF10CCN, MF10ACWM, MF10CCWM			MF10CCJ, MF10AJ			Units
			Typical (Note 8)	Tested Limit (Note 9)	Design Limit (Note 10)	Typical (Note 8)	Tested Limit (Note 9)	Design Limit (Note 10)	
V <sub>OUT</sub>	Minimum Output Voltage Swing	BP, LP Pins	R <sub>L</sub> = 5k	±4.25	±3.8	± <b>3.8</b>	±4.25	± <b>3.8</b>	V
		N/AP/HP Pin	R <sub>L</sub> = 3.5k	±4.25	±3.8	± <b>3.8</b>	±4.25	± <b>3.6</b>	V
GBW	Op Amp Gain BW Product			2.5			2.5		MHz
SR	Op Amp Slew Rate			7			7		V/μs
	Dynamic Range (Note 6)		V <sub>pin12</sub> = +5V (f <sub>CLK</sub> /f <sub>O</sub> = 50)	83			83		dB
			V <sub>pin12</sub> = 0V (f <sub>CLK</sub> /f <sub>O</sub> = 100)	80			80		dB
I <sub>SC</sub>	Maximum Output Short Circuit Current (Note 7)	Source		20			20		mA
		Sink		3.0			3.0		mA

**Logic Input Characteristics** **Boldface limits apply for  $T_{MIN}$  to  $T_{MAX}$** ; all other limits  $T_A = T_J = 25^\circ C$

Parameter	Conditions	MF10ACN, MF10CCN, MF10ACWM, MF10CCWM			MF10CCJ, MF10AJ			Units
		Typical (Note 8)	Tested Limit (Note 9)	Design Limit (Note 10)	Typical (Note 8)	Tested Limit (Note 9)	Design Limit (Note 10)	
CMOS Clock Input Voltage	Min Logical "1"	V <sup>+</sup> = +5V, V <sup>-</sup> = -5V, V <sub>LSh</sub> = 0V		+3.0	+ <b>3.0</b>		+ <b>3.0</b>	V
	Max Logical "0"			-3.0	- <b>3.0</b>		- <b>3.0</b>	V
	Min Logical "1"	V <sup>+</sup> = +10V, V <sup>-</sup> = 0V, V <sub>LSh</sub> = +5V		+8.0	+ <b>8.0</b>		+ <b>8.0</b>	V
	Max Logical "0"			+2.0	+ <b>2.0</b>		+ <b>2.0</b>	V
TTL Clock Input Voltage	Min Logical "1"	V <sup>+</sup> = +5V, V <sup>-</sup> = -5V, V <sub>LSh</sub> = 0V		+2.0	+ <b>2.0</b>		+ <b>2.0</b>	V
	Max Logical "0"			+0.8	+ <b>0.8</b>		+ <b>0.8</b>	V
	Min Logical "1"	V <sup>+</sup> = +10V, V <sup>-</sup> = 0V, V <sub>LSh</sub> = 0V		+2.0	+ <b>2.0</b>		+ <b>2.0</b>	V
	Max Logical "0"			+0.8	+ <b>0.8</b>		+ <b>0.8</b>	V

**Note 1:** Absolute Maximum Ratings indicate limits beyond which damage to the device may occur. DC and AC electrical specifications do not apply when operating the device beyond its specified operating conditions.

**Note 2:** When the input voltage (V<sub>IN</sub>) at any pin exceeds the power supply rails (V<sub>IN</sub> < V<sup>-</sup> or V<sub>IN</sub> > V<sup>+</sup>) the absolute value of current at that pin should be limited to 5 mA or less. The 20 mA package input current limits the number of pins that can exceed the power supply boundaries with a 5 mA current limit to four.

**Note 3:** The maximum power dissipation must be derated at elevated temperatures and is dictated by T<sub>JMAX</sub>, θ<sub>JA</sub>, and the ambient temperature, T<sub>A</sub>. The maximum allowable power dissipation at any temperature is P<sub>D</sub> = (T<sub>JMAX</sub> - T<sub>A</sub>)/θ<sub>JA</sub> or the number given in the Absolute Maximum Ratings, whichever is lower. For this device, T<sub>JMAX</sub> = 125°C, and the typical junction-to-ambient thermal resistance of the MF10ACN/CCN when board mounted is 55°C/W. For the MF10AJ/CCJ, this number increases to 95°C/W and for the MF10ACWM/CCWM this number is 66°C/W.

**Note 4:** The accuracy of the Q value is a function of the center frequency (f<sub>O</sub>). This is illustrated in the curves under the heading "Typical Performance Characteristics".

**Note 5:** V<sub>OS1</sub>, V<sub>OS2</sub>, and V<sub>OS3</sub> refer to the internal offsets as discussed in the Applications Information Section 3.4.

**Note 6:** For ±5V supplies the dynamic range is referenced to 2.82V rms (4V peak) where the wideband noise over a 20 kHz bandwidth is typically 200 μV rms for the MF10 with a 50:1 CLK ratio and 280 μV rms for the MF10 with a 100:1 CLK ratio.

**Note 7:** The short circuit source current is measured by forcing the output that is being tested to its maximum positive voltage swing and then shorting that output to the negative supply. The short circuit sink current is measured by forcing the output that is being tested to its maximum negative voltage swing and then shorting that output to the positive supply. These are the worst case conditions.

**Note 8:** Typical values are at 25°C and represent most likely parametric norm.

**Note 9:** Tested limits are guaranteed to National's AOQL (Average Outgoing Quality Level).

**Note 10:** Design limits are guaranteed but not 100% tested. These limits are not used to calculate outgoing quality levels.

**Note 11:** Human body model, 100 pF discharged through a 1.5 kΩ resistor.

# Typical Performance Characteristics

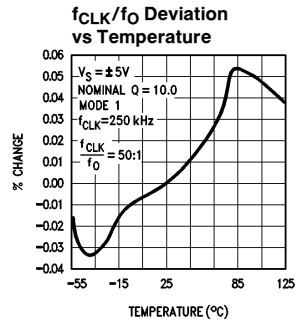
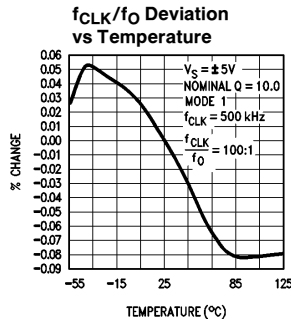
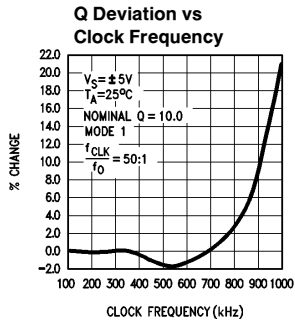
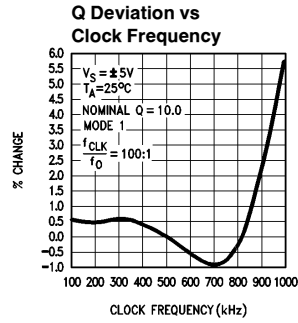
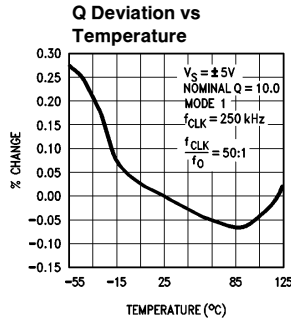
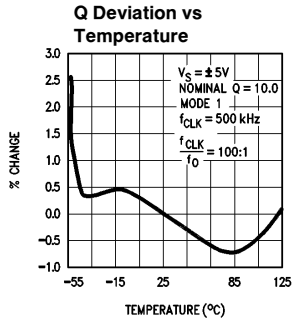
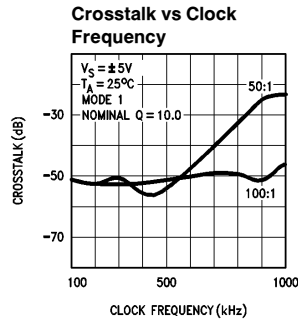
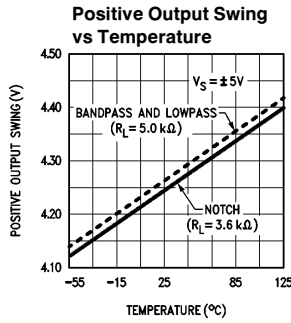
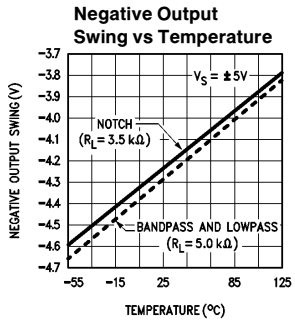
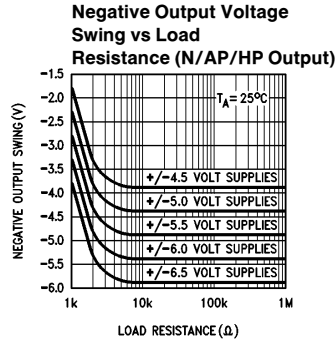
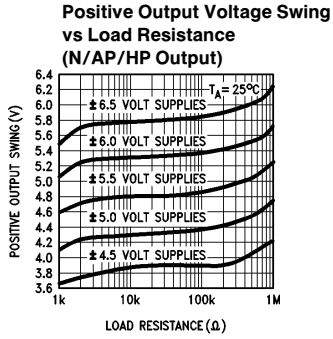
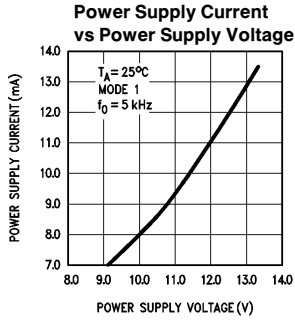

TL/H/10399-2

## Typical Performance Characteristics (Continued)

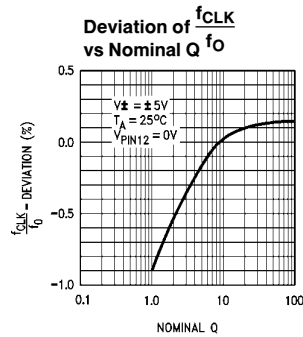
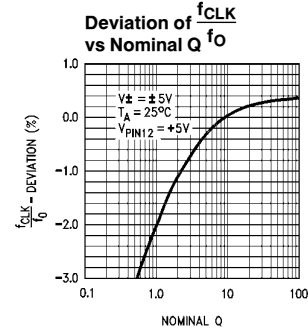
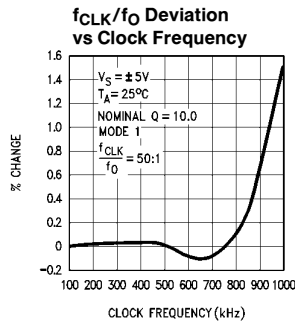
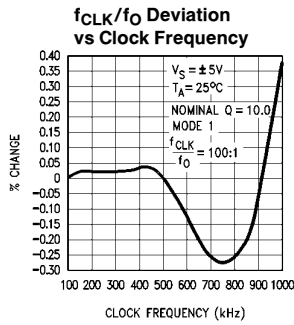

TL/H/10399-3

## Pin Descriptions

LP(1,20), BP(2,19), The second order lowpass, bandpass and notch/allpass/highpass outputs. These outputs can typically sink 1.5 mA and source 3 mA. Each output typically swings to within 1V of each supply.

INV(4,17) The inverting input of the summing op-amp of each filter. These are high impedance inputs, but the non-inverting input is internally tied to AGND, making  $INV_A$  and  $INV_B$  behave like summing junctions (low impedance, current inputs).

S1(5,16) S1 is a signal input pin used in the all-pass filter configurations (see modes 4 and 5). The pin should be driven with a source impedance of less than 1 k $\Omega$ . If S1 is not driven with a signal it should be tied to AGND (mid-supply).

$S_{A/B}$ (6)

This pin activates a switch that connects one of the inputs of each filter's second summer to either AGND ( $S_{A/B}$  tied to  $V^-$ ) or to the lowpass (LP) output ( $S_{A/B}$  tied to  $V^+$ ). This offers the flexibility needed for configuring the filter in its various modes of operation.

$V_A^+$  (7),  $V_D^+$  (8)

Analog positive supply and digital positive supply. These pins are internally connected through the IC substrate and therefore  $V_A^+$  and  $V_D^+$  should be derived from the same power supply source. They have been brought out separately so they can be bypassed by separate capacitors, if desired. They can be externally tied together and bypassed by a single capacitor.

$V_A^-$  (14),  $V_D^-$  (13)

Analog and digital negative supplies. The same comments as for  $V_A^+$  and  $V_D^+$  apply here.

## Pin Descriptions (Continued)

LSh(9)	Level shift pin; it accommodates various clock levels with dual or single supply operation. With dual $\pm 5V$ supplies, the MF10 can be driven with CMOS clock levels ( $\pm 5V$ ) and the LSh pin should be tied to the system ground. If the same supplies as above are used but only TTL clock levels, derived from 0V to +5V supply, are available, the LSh pin should be tied to the system ground. For single supply operation (0V and +10V) the $V_A^-$ , $V_D^-$ pins should be connected to the system ground, the AGND pin should be biased at +5V and the LSh pin should also be tied to the system ground for TTL clock levels. LSh should be biased at +5V for CMOS clock levels in 10V single-supply applications.
CLKA(10), CLKB(11)	Clock inputs for each switched capacitor filter building block. They should both be of the same level (TTL or CMOS). The level shift (LSh) pin description discusses how to accommodate their levels. The duty cycle of the clock should be close to 50% especially when clock frequencies above 200 kHz are used. This allows the maximum time for the internal op-amps to settle, which yields optimum filter operation.
50/100/CL(12)	By tying this pin high a 50:1 clock-to-filter-center-frequency ratio is obtained. Tying this pin at mid-supplies (i.e., analog ground with dual supplies) allows the filter to operate at a 100:1 clock-to-center-frequency ratio. When the pin is tied low (i.e., negative supply with dual supplies), a simple current limiting circuit is triggered to limit the overall supply current down to about 2.5 mA. The filtering action is then aborted.
AGND(15)	This is the analog ground pin. This pin should be connected to the system ground for dual supply operation or biased to mid-supply for single supply operation. For a further discussion of mid-supply biasing techniques see the Applications Information (Section 3.2). For optimum filter performance a "clean" ground must be provided.

## 1.0 Definition of Terms

**f<sub>CLK</sub>**: the frequency of the external clock signal applied to pin 10 or 11.

**f<sub>O</sub>**: center frequency of the second order function complex pole pair.  $f_O$  is measured at the bandpass outputs of the MF10, and is the frequency of maximum bandpass gain. (Figure 1)

**f<sub>notch</sub>**: the frequency of minimum (ideally zero) gain at the notch outputs.

**f<sub>z</sub>**: the center frequency of the second order complex zero pair, if any. If  $f_z$  is different from  $f_O$  and if  $Q_Z$  is high, it can be observed as the frequency of a notch at the allpass output. (Figure 10)

**Q**: "quality factor" of the 2nd order filter. Q is measured at the bandpass outputs of the MF10 and is equal to  $f_O$  divided by the  $-3$  dB bandwidth of the 2nd order bandpass filter (Figure 1). The value of Q determines the shape of the 2nd order filter responses as shown in Figure 6.

**Q<sub>Z</sub>**: the quality factor of the second order complex zero pair, if any.  $Q_Z$  is related to the allpass characteristic, which is written:

$$H_{AP}(s) = \frac{H_{OAP} \left( s^2 - \frac{s\omega_O}{Q_Z} + \omega_O^2 \right)}{s^2 + \frac{s\omega_O}{Q} + \omega_O^2}$$

where  $Q_Z = Q$  for an all-pass response.

**H<sub>OBP</sub>**: the gain (in V/V) of the bandpass output at  $f = f_O$ .

**H<sub>OLP</sub>**: the gain (in V/V) of the lowpass output as  $f \rightarrow 0$  Hz (Figure 2).

**H<sub>OHP</sub>**: the gain (in V/V) of the highpass output as  $f \rightarrow f_{CLK}/2$  (Figure 3).

**H<sub>ON</sub>**: the gain (in V/V) of the notch output as  $f \rightarrow 0$  Hz and as  $f \rightarrow f_{CLK}/2$ , when the notch filter has equal gain above and below the center frequency (Figure 4). When the low-frequency gain differs from the high-frequency gain, as in modes 2 and 3a (Figures 11 and 8), the two quantities below are used in place of  $H_{ON}$ .

**H<sub>ON1</sub>**: the gain (in V/V) of the notch output as  $f \rightarrow 0$  Hz.

**H<sub>ON2</sub>**: the gain (in V/V) of the notch output as  $f \rightarrow f_{CLK}/2$ .

## 1.0 Definition of Terms (Continued)

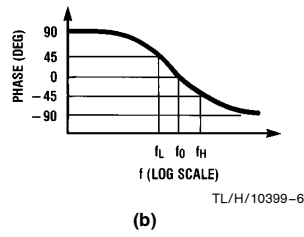
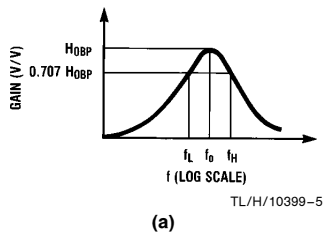

$$H_{BP}(s) = \frac{H_{OBP} \frac{\omega_0}{Q} s}{s^2 + \frac{s\omega_0}{Q} + \omega_0^2}$$

$$Q = \frac{f_0}{f_H - f_L}; f_0 = \sqrt{f_L f_H}$$

$$f_L = f_0 \left( \frac{-1}{2Q} + \sqrt{\left(\frac{1}{2Q}\right)^2 + 1} \right)$$

$$f_H = f_0 \left( \frac{1}{2Q} + \sqrt{\left(\frac{1}{2Q}\right)^2 + 1} \right)$$

$$\omega_0 = 2\pi f_0$$

FIGURE 1. 2nd-Order Bandpass Response

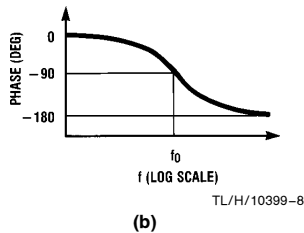
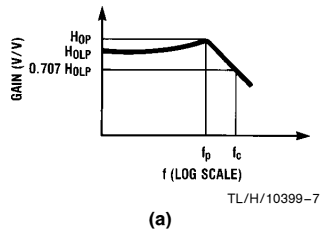

$$H_{LP}(s) = \frac{H_{OLP} \omega_0^2}{s^2 + \frac{s\omega_0}{Q} + \omega_0^2}$$

$$f_c = f_0 \times \sqrt{\left(1 - \frac{1}{2Q^2}\right) + \sqrt{\left(1 - \frac{1}{2Q^2}\right)^2 + 1}}$$

$$f_p = f_0 \sqrt{1 - \frac{1}{2Q^2}}$$

$$H_{OP} = H_{OLP} \times \frac{1}{\frac{1}{Q} \sqrt{1 - \frac{1}{4Q^2}}}$$

FIGURE 2. 2nd-Order Low-Pass Response

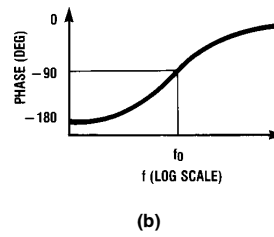
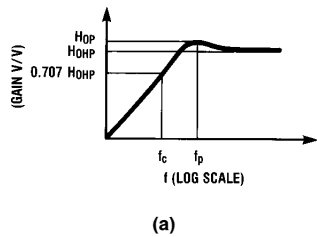

$$H_{HP}(s) = \frac{H_{OHP} s^2}{s^2 + \frac{s\omega_0}{Q} + \omega_0^2}$$

$$f_c = f_0 \times \left[ \sqrt{\left(1 - \frac{1}{2Q^2}\right) + \sqrt{\left(1 - \frac{1}{2Q^2}\right)^2 + 1}} \right]^{-1}$$

$$f_p = f_0 \times \left[ \sqrt{1 - \frac{1}{2Q^2}} \right]^{-1}$$

$$H_{OP} = H_{OHP} \times \frac{1}{\frac{1}{Q} \sqrt{1 - \frac{1}{4Q^2}}}$$

FIGURE 3. 2nd-Order High-Pass Response

# 1.0 Definitions of Terms (Continued)

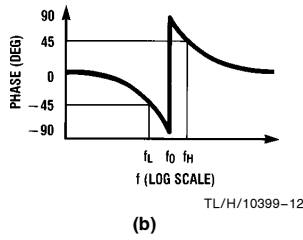
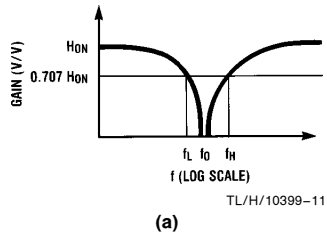

$$H_N(s) = \frac{H_{ON}(s^2 + \omega_0^2)}{s^2 + \frac{s\omega_0}{Q} + \omega_0^2}$$

$$Q = \frac{f_0}{f_H - f_L}; f_0 = \sqrt{f_L f_H}$$

$$f_L = f_0 \left( \frac{-1}{2Q} + \sqrt{\left(\frac{1}{2Q}\right)^2 + 1} \right)$$

$$f_H = f_0 \left( \frac{1}{2Q} + \sqrt{\left(\frac{1}{2Q}\right)^2 + 1} \right)$$

FIGURE 4. 2nd-Order Notch Response

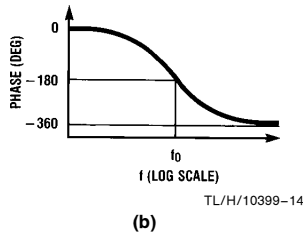
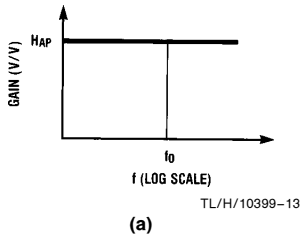

$$H_{AP}(s) = \frac{H_{AP} \left( s^2 - \frac{s\omega_0}{Q} + \omega_0^2 \right)}{s^2 + \frac{s\omega_0}{Q} + \omega_0^2}$$

FIGURE 5. 2nd-Order All-Pass Response

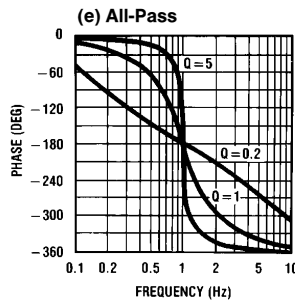
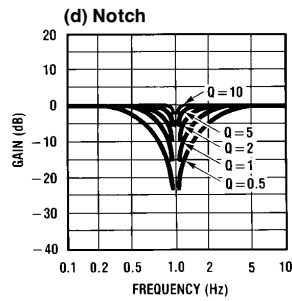
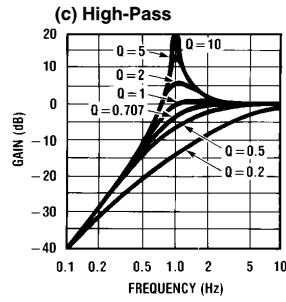
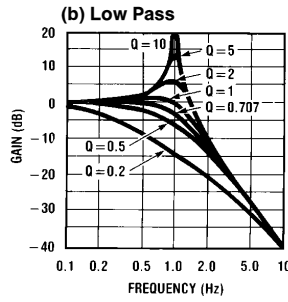
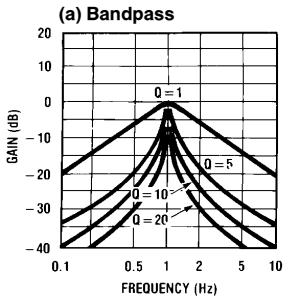

FIGURE 6. Response of various 2nd-order filters as a function of Q. Gains and center frequencies are normalized to unity.

TL/H/10399-15



## 2.0 Modes of Operation

The MF10 is a switched capacitor (sampled data) filter. To fully describe its transfer functions, a time domain approach is appropriate. Since this is cumbersome, and since the MF10 closely approximates continuous filters, the following discussion is based on the well know frequency domain. Each MF10 can produce a full 2nd order function. See Table I for a summary of the characteristics of the various modes.

### MODE 1: Notch 1, Bandpass, Lowpass Outputs:

$$f_{\text{notch}} = f_0 \text{ (See Figure 7)}$$

$f_0$  = center frequency of the complex pole pair

$$= \frac{f_{\text{CLK}}}{100} \text{ or } \frac{f_{\text{CLK}}}{50}$$

$f_{\text{notch}}$  = center frequency of the imaginary zero pair =  $f_0$ .

$$H_{\text{OLP}} = \text{Lowpass gain (as } f \rightarrow 0) = -\frac{R_2}{R_1}$$

$$H_{\text{OBP}} = \text{Bandpass gain (at } f = f_0) = \frac{R_3}{R_1}$$

$$H_{\text{ON}} = \text{Notch output gain as } \left. \begin{array}{l} f \rightarrow 0 \\ f \rightarrow f_{\text{CLK}}/2 \end{array} \right\} = \frac{-R_2}{R_1}$$

$$Q = \frac{f_0}{\text{BW}} = \frac{R_3}{R_2}$$

= quality factor of the complex pole pair

BW = the -3 dB bandwidth of the bandpass output.

Circuit dynamics:

$$H_{\text{OLP}} = \frac{H_{\text{OBP}}}{Q} \text{ or } H_{\text{OBP}} = H_{\text{OLP}} \times Q$$

$$= H_{\text{ON}} \times Q.$$

$$H_{\text{OLP(peak)}} \cong Q \times H_{\text{OLP}} \text{ (for high Q's)}$$

### MODE 1a: Non-Inverting BP, LP (See Figure 8)

$$f_0 = \frac{f_{\text{CLK}}}{100} \text{ or } \frac{f_{\text{CLK}}}{50}$$

$$Q = \frac{R_3}{R_2}$$

$$H_{\text{OLP}} = -1; H_{\text{OLP(peak)}} \cong Q \times H_{\text{OLP}} \text{ (for high Q's)}$$

$$H_{\text{OBP}_1} = -\frac{R_3}{R_2}$$

$$H_{\text{OBP}_2} = 1 \text{ (Non-Inverting)}$$

Circuit Dynamics:  $H_{\text{OBP}_1} = Q$

Note:  $V_{\text{IN}}$  should be driven from a low impedance (<1 k $\Omega$ ) source.

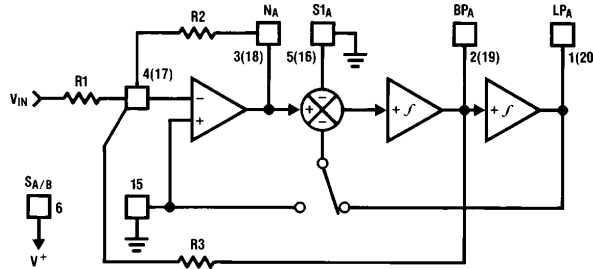

FIGURE 7. MODE 1

TL/H/10399-16

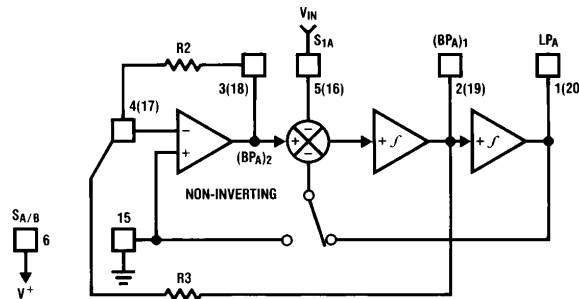

FIGURE 8. MODE 1a

TL/H/10399-17



## 2.0 Modes of Operation (Continued)

### MODE 3a: HP, BP, LP and Notch with External Op Amp (See Figure 11)

$$f_0 = \frac{f_{CLK}}{100} \times \sqrt{\frac{R_2}{R_4}} \text{ or } \frac{f_{CLK}}{50} \times \sqrt{\frac{R_2}{R_4}}$$

$$Q = \sqrt{\frac{R_2}{R_4}} \times \frac{R_3}{R_2}$$

$$H_{OHP} = \frac{R_2}{R_1}$$

$$H_{OBP} = \frac{R_3}{R_1}$$

$$H_{OLP} = \frac{R_4}{R_1}$$

$$f_n = \text{notch frequency} = \frac{f_{CLK}}{100} \sqrt{\frac{R_h}{R_l}} \text{ or } \frac{f_{CLK}}{50} \sqrt{\frac{R_h}{R_l}}$$

$H_{ON}$  = gain of notch at

$$f = f_0 = \left\| Q \left( \frac{R_g}{R_l} H_{OLP} - \frac{R_g}{R_h} H_{OHP} \right) \right\|$$

$$H_{n1} = \text{gain of notch (as } f \rightarrow 0) = \frac{R_g}{R_l} \times H_{OLP}$$

$$H_{n2} = \text{gain of notch (as } f \rightarrow \frac{f_{CLK}}{2}) = \frac{R_g}{R_h} \times H_{OHP}$$

### MODE 4: Allpass, Bandpass, Lowpass Outputs (See Figure 12)

$f_0$  = center frequency

$$= \frac{f_{CLK}}{100} \text{ or } \frac{f_{CLK}}{50}$$

$f_z^*$  = center frequency of the complex zero  $\approx f_0$

$$Q = \frac{f_0}{BW} = \frac{R_3}{R_2}$$

$$Q_z = \text{quality factor of complex zero pair} = \frac{R_3}{R_1}$$

For AP output make  $R_1 = R_2$

$$H_{OAP}^* = \text{Allpass gain (at } 0 < f < \frac{f_{CLK}}{2}) = -\frac{R_2}{R_1} = -1$$

$H_{OLP}$  = Lowpass gain (as  $f \rightarrow 0$ )

$$= -\left(\frac{R_2}{R_1} + 1\right) = -2$$

$H_{OBP}$  = Bandpass gain (at  $f = f_0$ )

$$= -\frac{R_3}{R_2} \left(1 + \frac{R_2}{R_1}\right) = -2 \left(\frac{R_3}{R_2}\right)$$

Circuit Dynamics:  $H_{OBP} = (H_{OLP}) \times Q = (H_{OAP} + 1)Q$

\*Due to the sampled data nature of the filter, a slight mismatch of  $f_z$  and  $f_0$  occurs causing a 0.4 dB peaking around  $f_0$  of the allpass filter amplitude response (which theoretically should be a straight line). If this is unacceptable, Mode 5 is recommended.

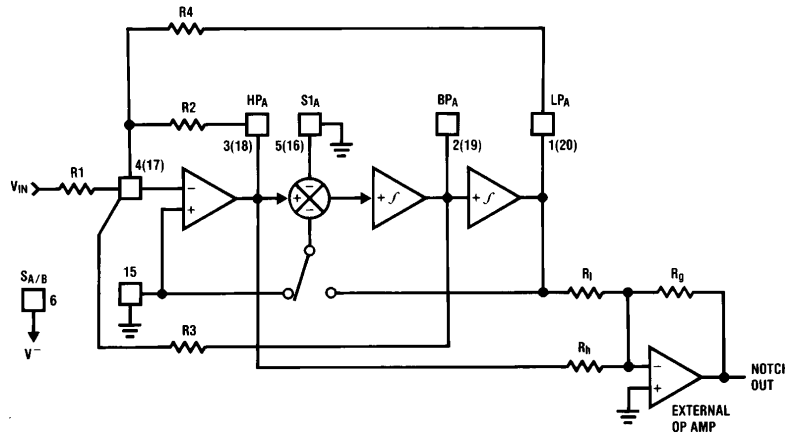

FIGURE 11. MODE 3a

TL/H/10399-20

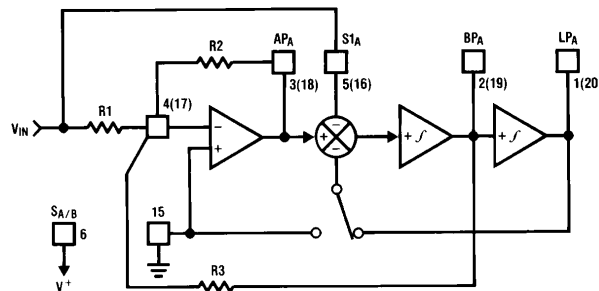

FIGURE 12. MODE 4

TL/H/10399-21

## 2.0 Modes of Operation (Continued)

### MODE 5: Numerator Complex Zeros, BP, LP (See Figure 13)

$$f_o = \sqrt{1 + \frac{R_2}{R_4}} \times \frac{f_{CLK}}{100} \text{ or } \sqrt{1 + \frac{R_2}{R_4}} \times \frac{f_{CLK}}{50}$$

$$f_z = \sqrt{1 - \frac{R_2}{R_4}} \times \frac{f_{CLK}}{100} \text{ or } \sqrt{1 - \frac{R_1}{R_4}} \times \frac{f_{CLK}}{50}$$

$$Q = \sqrt{1 + \frac{R_2}{R_4}} \times \frac{R_3}{R_2}$$

$$Q_z = \sqrt{1 - \frac{R_1}{R_4}} \times \frac{R_3}{R_1}$$

$H_{0z1}$  = gain at C.Z. output (as  $f \rightarrow 0$  Hz)

$$\frac{-R_2(R_4 - R_1)}{R_1(R_2 + R_4)}$$

$H_{0z2}$  = gain at C.Z. output (as  $f \rightarrow \frac{f_{CLK}}{2}$ ) =  $\frac{-R_2}{R_1}$

$$H_{OBP} = -\left(\frac{R_2}{R_1} + 1\right) \times \frac{R_3}{R_2}$$

$$H_{OLP} = -\left(\frac{R_2 + R_1}{R_2 + R_4}\right) \times \frac{R_4}{R_1}$$

### MODE 6a: Single Pole, HP, LP Filter (See Figure 14)

$f_c$  = cutoff frequency of LP or HP output

$$= \frac{R_2}{R_3} \frac{f_{CLK}}{100} \text{ or } \frac{R_2}{R_3} \frac{f_{CLK}}{50}$$

$$H_{OLP} = -\frac{R_3}{R_1}$$

$$H_{OHP} = -\frac{R_2}{R_1}$$

### MODE 6b: Single Pole LP Filter (Inverting and Non-Inverting) (See Figure 15)

$f_c$  = cutoff frequency of LP outputs

$$\cong \frac{R_2}{R_3} \frac{f_{CLK}}{100} \text{ or } \frac{R_2}{R_3} \frac{f_{CLK}}{50}$$

$H_{OLP1} = 1$  (non-inverting)

$$H_{OLP2} = -\frac{R_3}{R_2}$$

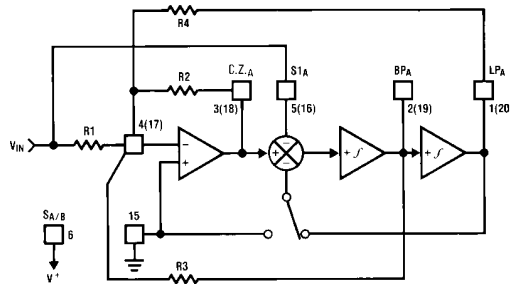

FIGURE 13. MODE 5

TL/H/10399-22

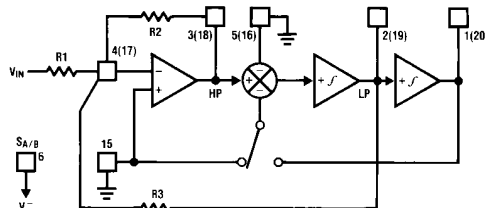

FIGURE 14. MODE 6a

TL/H/10399-23

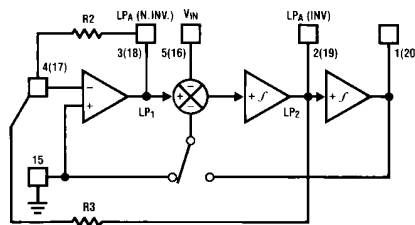

FIGURE 15. MODE 6b

TL/H/10399-24

## 2.0 Modes of Operation (Continued)

**TABLE I. Summary of Modes. Realizable filter types (e.g. low-pass) denoted by asterisks. Unless otherwise noted, gains of various filter outputs are inverting and adjustable by resistor ratios.**

Mode	BP	LP	HP	N	AP	Number of Resistors	Adjustable $f_{CLK}/f_0$	Notes
1	*	*		*		3	No	
1a	(2) $H_{OBP1} = -Q$ $H_{OBP2} = +1$	$H_{OLP} + 1$				2	No	May need input buffer. Poor dynamics for high Q.
2	*	*		*		3	Yes (above $f_{CLK}/50$ or $f_{CLK}/100$ )	
3	*	*	*			4	Yes	Universal State-Variable Filter. Best general-purpose mode.
3a	*	*	*	*		7	Yes	As above, but also includes resistor-tuneable notch.
4	*	*			*	3	No	Gives Allpass response with $H_{OAP} = -1$ and $H_{OLP} = -2$ .
5	*	*			*	4		Gives flatter allpass response than above if $R_1 = R_2 = 0.02R_4$ .
6a		*	*			3		Single pole.
6b		(2) $H_{OLP1} = +1$ $H_{OLP2} = \frac{-R3}{R2}$				2		Single Pole.

## 3.0 Applications Information

The MF10 is a general-purpose dual second-order state variable filter whose center frequency is proportional to the frequency of the square wave applied to the clock input ( $f_{CLK}$ ). By connecting pin 12 to the appropriate DC voltage, the filter center frequency  $f_0$  can be made equal to either  $f_{CLK}/100$  or  $f_{CLK}/50$ .  $f_0$  can be very accurately set (within  $\pm 6\%$ ) by using a crystal clock oscillator, or can be easily varied over a wide frequency range by adjusting the clock frequency. If desired, the  $f_{CLK}/f_0$  ratio can be altered by external resistors as in *Figures 9, 10, 11, 13, 14* and *15*. The filter Q and gain are determined by external resistors.

All of the five second-order filter types can be built using either section of the MF10. These are illustrated in *Figures 1* through *5* along with their transfer functions and some related equations. *Figure 6* shows the effect of Q on the shapes of these curves. When filter orders greater than two are desired, two or more MF10 sections can be cascaded.

### 3.1 DESIGN EXAMPLE

In order to design a second-order filter section using the MF10, we must define the necessary values of three parameters:  $f_0$ , the filter section's center frequency;  $H_0$ , the passband gain; and the filter's Q. These are determined by the characteristics required of the filter being designed.

As an example, let's assume that a system requires a fourth-order Chebyshev low-pass filter with 1 dB ripple, unity gain at DC, and 1000 Hz cutoff frequency. As the system order is four, it is realizable using both second-order sections of an MF10. Many filter design texts include tables that list the characteristics ( $f_0$  and Q) of each of the second-order filter sections needed to synthesize a given higher-order

filter. For the Chebyshev filter defined above, such a table yields the following characteristics:

$$f_{0A} = 529 \text{ Hz} \quad Q_A = 0.785$$

$$f_{0B} = 993 \text{ Hz} \quad Q_B = 3.559$$

For unity gain at DC, we also specify:

$$H_{0A} = 1$$

$$H_{0B} = 1$$

The desired clock-to-cutoff-frequency ratio for the overall filter of this example is 100 and a 100 kHz clock signal is available. Note that the required center frequencies for the two second-order sections will not be obtainable with clock-to-center-frequency ratios of 50 or 100. It will be necessary

to adjust  $\frac{f_{CLK}}{f_0}$  externally. From Table I, we see that Mode 3 can be used to produce a low-pass filter with resistor-adjustable center frequency.

In most filter designs involving multiple second-order stages, it is best to place the stages with lower Q values ahead of stages with higher Q, especially when the higher Q is greater than 0.707. This is due to the higher relative gain at the center frequency of a higher-Q stage. Placing a stage with lower Q ahead of a higher-Q stage will provide some attenuation at the center frequency and thus help avoid clipping of signals near this frequency. For this example, stage A has the lower Q (0.785) so it will be placed ahead of the other stage.

For the first section, we begin the design by choosing a convenient value for the input resistance:  $R_{1A} = 20k$ . The absolute value of the passband gain  $H_{OLPA}$  is made equal

### 3.0 Applications Information (Continued)

to 1 by choosing  $R_{4A}$  such that:  $R_{4A} = -H_{OLPA} R_{1A} = R_{1A} = 20k$ . If the 50/100/CL pin is connected to mid-supply for nominal 100:1 clock-to-center-frequency ratio, we find  $R_{2A}$  by:

$$R_{2A} = R_{4A} \frac{f_{0A}^2}{(f_{CLK}/100)^2} = 2 \times 10^4 \times \frac{(529)^2}{(1000)^2} = 5.6k \text{ and}$$

$$R_{3A} = Q_A \sqrt{R_{2A} R_{4A}} = 0.785 \sqrt{5.6 \times 10^3 \times 2 \times 10^4} = 8.3k$$

The resistors for the second section are found in a similar fashion:

$$R_{1B} = 20k$$

$$R_{4B} = R_{1B} = 20k$$

$$R_{2B} = R_{4B} \frac{f_{0B}^2}{(f_{CLK}/100)^2} = 20k \frac{(993)^2}{(1000)^2} = 19.7k$$

$$R_{3B} = Q_B \sqrt{R_{2B} R_{4B}} = 3.559 \sqrt{19.7 \times 10^3 \times 2 \times 10^4} = 70.6k$$

The complete circuit is shown in *Figure 16* for split  $\pm 5V$  power supplies. Supply bypass capacitors are highly recommended.

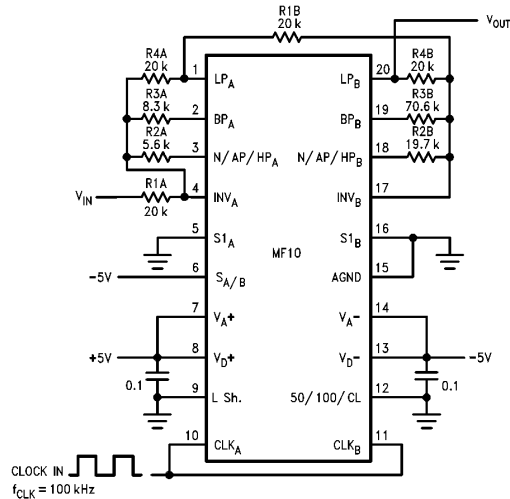

TL/H/10399-25

**FIGURE 16. Fourth-Order Chebyshev Low-Pass Filter from Example in 3.1.  $\pm 5V$  Power Supply. 0V–5V TTL or  $-5V \pm 5V$  CMOS Logic Levels.**

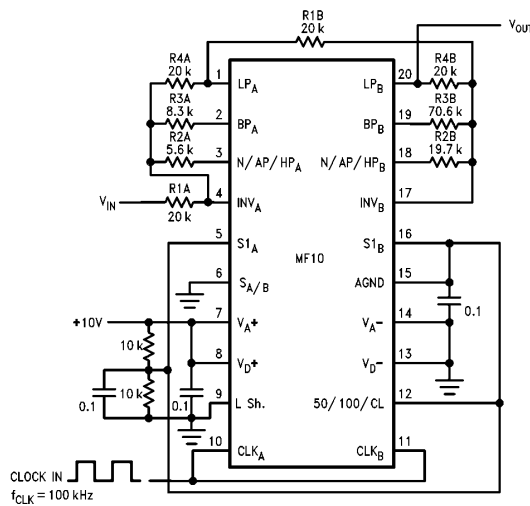

TL/H/10399-26

**FIGURE 17. Fourth-Order Chebyshev Low-Pass Filter from Example in 3.1. Single +10V Power Supply. 0V–5V TTL Logic Levels. Input Signals Should be Referred to Half-Supply or Applied through a Coupling Capacitor.**

### 3.0 Applications Information (Continued)

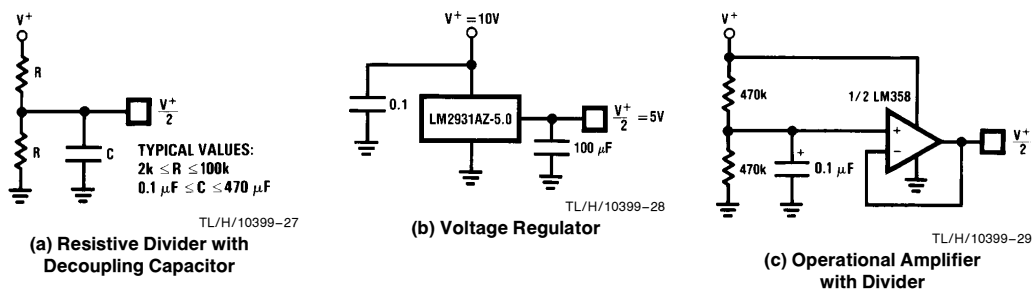

FIGURE 18. Three Ways of Generating  $\frac{V^+}{2}$  for Single-Supply Operation

#### 3.2 SINGLE SUPPLY OPERATION

The MF10 can also operate with a single-ended power supply. Figure 17 shows the example filter with a single-ended power supply.  $V_{A^+}$  and  $V_{D^+}$  are again connected to the positive power supply (8V to 14V), and  $V_{A^-}$  and  $V_{D^-}$  are connected to ground. The  $A_{GND}$  pin must be tied to  $V^+/2$  for single supply operation. This half-supply point should be very "clean", as any noise appearing on it will be treated as an input to the filter. It can be derived from the supply voltage with a pair of resistors and a bypass capacitor (Figure 18a), or a low-impedance half-supply voltage can be made using a three-terminal voltage regulator or an operational amplifier (Figures 18b and 18c). The passive resistor divider with a bypass capacitor is sufficient for many applications, provided that the time constant is long enough to reject any power supply noise. It is also important that the half-supply reference present a low impedance to the clock frequency, so at very low clock frequencies the regulator or op-amp approaches may be preferable because they will require smaller capacitors to filter the clock frequency. The main power supply voltage should be clean (preferably regulated) and bypassed with 0.1  $\mu$ F.

#### 3.3 DYNAMIC CONSIDERATIONS

The maximum signal handling capability of the MF10, like that of any active filter, is limited by the power supply voltages used. The amplifiers in the MF10 are able to swing to within about 1V of the supplies, so the input signals must be kept small enough that none of the outputs will exceed these limits. If the MF10 is operating on  $\pm 5V$ , for example, the outputs will clip at about 8  $V_{p-p}$ . The maximum input voltage multiplied by the filter gain should therefore be less than 8  $V_{p-p}$ .

Note that if the filter Q is high, the gain at the lowpass or highpass outputs will be much greater than the nominal filter gain (Figure 6). As an example, a lowpass filter with a Q of

10 will have a 20 dB peak in its amplitude response at  $f_O$ . If the nominal gain of the filter  $H_{OLP}$  is equal to 1, the gain at  $f_O$  will be 10. The maximum input signal at  $f_O$  must therefore be less than 800 mV<sub>p-p</sub> when the circuit is operated on  $\pm 5V$  supplies.

Also note that one output can have a reasonable small voltage on it while another is saturated. This is most likely for a circuit such as the notch in Mode 1 (Figure 7). The notch output will be very small at  $f_O$ , so it might appear safe to apply a large signal to the input. However, the bandpass will have its maximum gain at  $f_O$  and can clip if overdriven. If one output clips, the performance at the other outputs will be degraded, so avoid overdriving any filter section, even ones whose outputs are not being directly used. Accompanying Figures 7 through 15 are equations labeled "circuit dynamics", which relate the Q and the gains at the various outputs. These should be consulted to determine peak circuit gains and maximum allowable signals for a given application.

#### 3.4 OFFSET VOLTAGE

The MF10's switched capacitor integrators have a higher equivalent input offset voltage than would be found in a typical continuous-time active filter integrator. Figure 19 shows an equivalent circuit of the MF10 from which the output DC offsets can be calculated. Typical values for these offsets with  $S_{A/B}$  tied to  $V^+$  are:

$$\begin{aligned} V_{os1} &= \text{opamp offset} = \pm 5 \text{ mV} \\ V_{os2} &= -150 \text{ mV @ 50:1} && -300 \text{ mV @ 100:1} \\ V_{os3} &= -70 \text{ mV @ 50:1} && -140 \text{ mV @ 100:1} \end{aligned}$$

When  $S_{A/B}$  is tied to  $V^-$ ,  $V_{os2}$  will approximately halve. The DC offset at the BP output is equal to the input offset of the lowpass integrator ( $V_{os3}$ ). The offsets at the other outputs depend on the mode of operation and the resistor ratios, as described in the following expressions.

### 3.0 Applications Information (Continued)

#### Mode 1 and Mode 4

$$V_{OS(N)} = V_{OS1} \left( \frac{1}{Q} + 1 \parallel H_{OLP} \right) - \frac{V_{OS3}}{Q}$$

$$V_{OS(BP)} = V_{OS3}$$

$$V_{OS(LP)} = V_{OS(N)} - V_{OS2}$$

#### Mode 1a

$$V_{OS(N.INV.BP)} = \left( 1 + \frac{1}{Q} \right) V_{OS1} - \frac{V_{OS3}}{Q}$$

$$V_{OS(INV.BP)} = V_{OS3}$$

$$V_{OS(LP)} = V_{OS(N.INV.BP)} - V_{OS2}$$

#### Mode 2 and Mode 5

$$V_{OS(N)} = \left( \frac{R2}{R_p} + 1 \right) V_{OS1} \times \frac{1}{1 + R2/R4} + V_{OS2} \frac{1}{1 + R4/R2} - \frac{V_{OS3}}{Q \sqrt{1 + R2/R4}}$$

$$R_p = R1 // R3 // R4$$

$$V_{OS(BP)} = V_{OS3}$$

$$V_{OS(LP)} = V_{OS(N)} - V_{OS2}$$

#### Mode 3

$$V_{OS(HP)} = V_{OS2}$$

$$V_{OS(BP)} = V_{OS3}$$

$$V_{OS(LP)} = V_{OS1} \left[ 1 + \frac{R4}{R_p} \right] - V_{OS2} \left( \frac{R4}{R2} \right)$$

$$- V_{OS3} \left( \frac{R4}{R3} \right)$$

$$R_p = R1 // R2 // R3$$

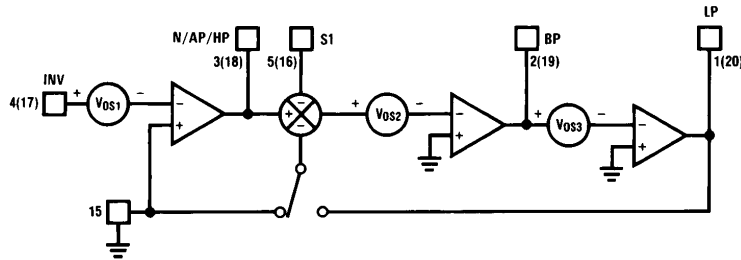

FIGURE 19. MF10 Offset Voltage Sources

TL/H/10399-30

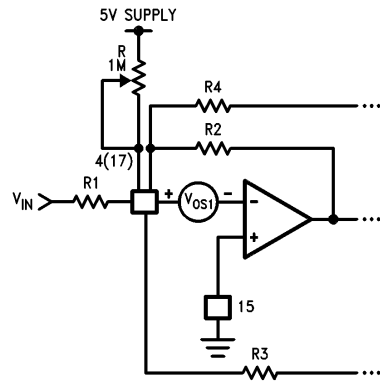

FIGURE 20. Method for Trimming  $V_{OS}$

TL/H/10399-31



### 3.0 Applications Information (Continued)

For most applications, the outputs are AC coupled and DC offsets are not bothersome unless large signals are applied to the filter input. However, larger offset voltages will cause clipping to occur at lower AC signal levels, and clipping at any of the outputs will cause gain nonlinearities and will change  $f_O$  and Q. When operating in Mode 3, offsets can become excessively large if R2 and R4 are used to make  $f_{CLK}/f_O$  significantly higher than the nominal value, especially if Q is also high. An extreme example is a bandpass filter having unity gain, a Q of 20, and  $f_{CLK}/f_O = 250$  with pin 12 tied to ground (100:1 nominal). R4/R2 will therefore be equal to 6.25 and the offset voltage at the lowpass output will be about +1V. Where necessary, the offset voltage can be adjusted by using the circuit of Figure 20. This allows adjustment of  $V_{OS1}$ , which will have varying effects on the different outputs as described in the above equations. Some outputs cannot be adjusted this way in some modes, however ( $V_{OS(BP)}$  in modes 1a and 3, for example).

#### 3.5 SAMPLED DATA SYSTEM CONSIDERATIONS

The MF10 is a sampled data filter, and as such, differs in many ways from conventional continuous-time filters. An important characteristic of sampled-data systems is their effect on signals at frequencies greater than one-half the sampling frequency. (The MF10's sampling frequency is the same as its clock frequency.) If a signal with a frequency greater than one-half the sampling frequency is applied to the input of a sampled data system, it will be "reflected" to a frequency less than one-half the sampling frequency. Thus, an input signal whose frequency is  $f_s/2 + 100$  Hz will cause the system to respond as though the input frequency

was  $f_s/2 - 100$  Hz. This phenomenon is known as "aliasing", and can be reduced or eliminated by limiting the input signal spectrum to less than  $f_s/2$ . This may in some cases require the use of a bandwidth-limiting filter ahead of the MF10 to limit the input spectrum. However, since the clock frequency is much higher than the center frequency, this will often not be necessary.

Another characteristic of sampled-data circuits is that the output signal changes amplitude once every sampling period, resulting in "steps" in the output voltage which occur at the clock rate (Figure 21). If necessary, these can be "smoothed" with a simple R-C low-pass filter at the MF10 output.

The ratio of  $f_{CLK}$  to  $f_C$  (normally either 50:1 or 100:1) will also affect performance. A ratio of 100:1 will reduce any aliasing problems and is usually recommended for wide-band input signals. In noise sensitive applications, however, a ratio of 50:1 may be better as it will result in 3 dB lower output noise. The 50:1 ratio also results in lower DC offset voltages, as discussed in Section 3.4.

The accuracy of the  $f_{CLK}/f_O$  ratio is dependent on the value of Q. This is illustrated in the curves under the heading "Typical Performance Characteristics". As Q is changed, the true value of the ratio changes as well. Unless the Q is low, the error in  $f_{CLK}/f_O$  will be small. If the error is too large for a specific application, use a mode that allows adjustment of the ratio with external resistors.

It should also be noted that the product of Q and  $f_O$  should be limited to 300 kHz when  $f_O < 5$  kHz, and to 200 kHz for  $f_O > 5$  kHz.

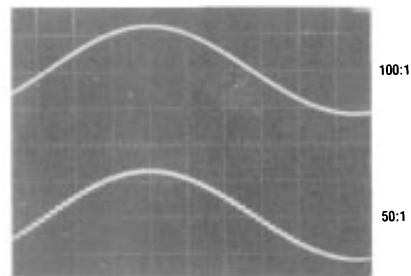

TL/H/10399-32

FIGURE 21. The Sampled-Data Output Waveform



**Physical Dimensions** inches (millimeters)

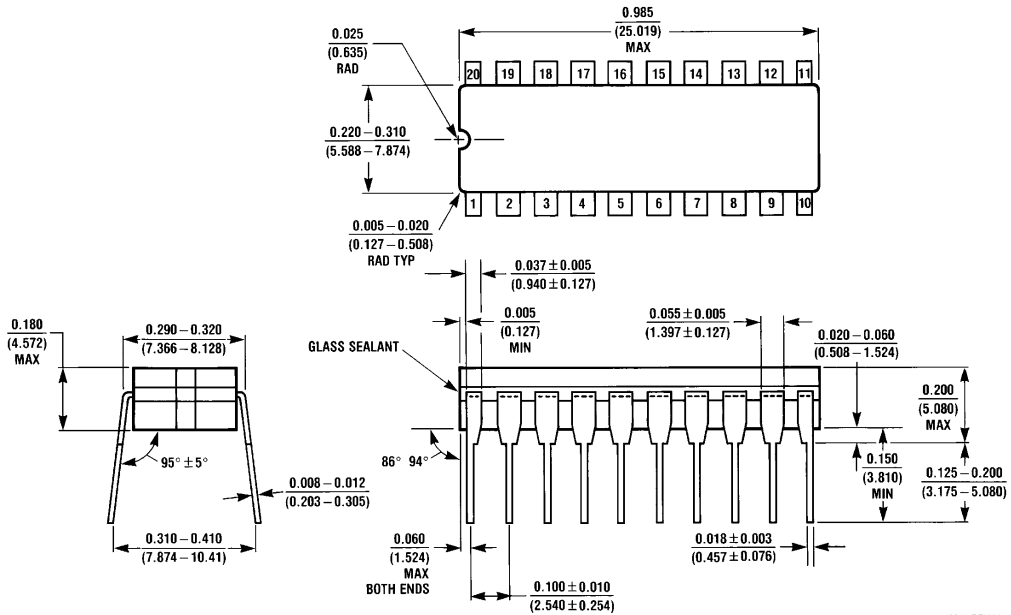

**20-Lead Ceramic Dual-In-Line Package (J)**  
**Order Number MF10AJ or MF10CCJ**  
**NS Package Number J20A**

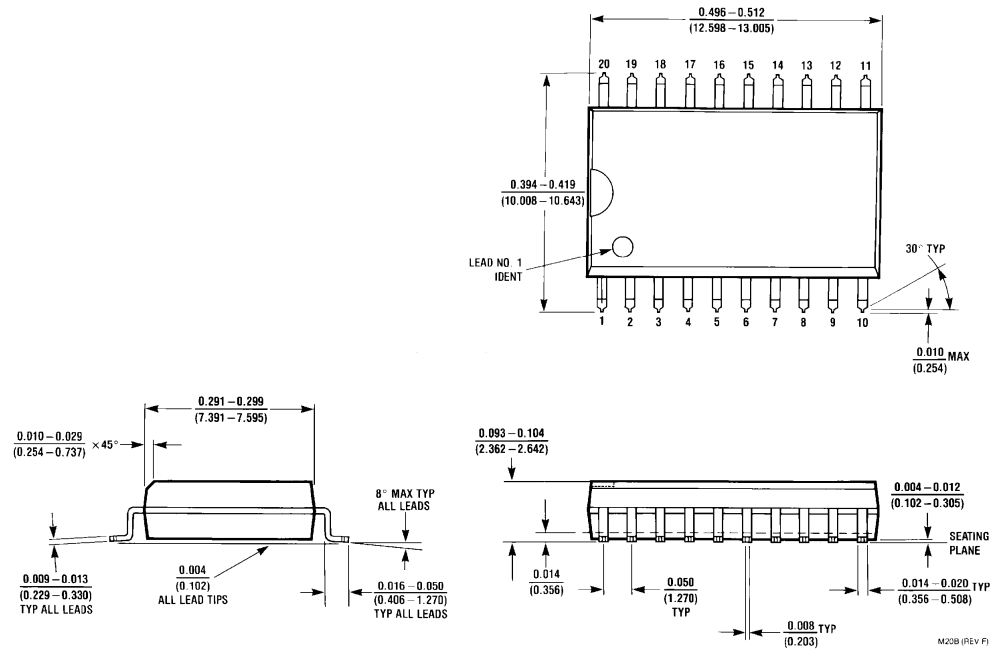

**Molded Package (Small Outline) (M)**  
**Order Number MF10ACWM or MF10CCWM**  
**NS Package Number M20B**

**Physical Dimensions** inches (millimeters) (Continued)

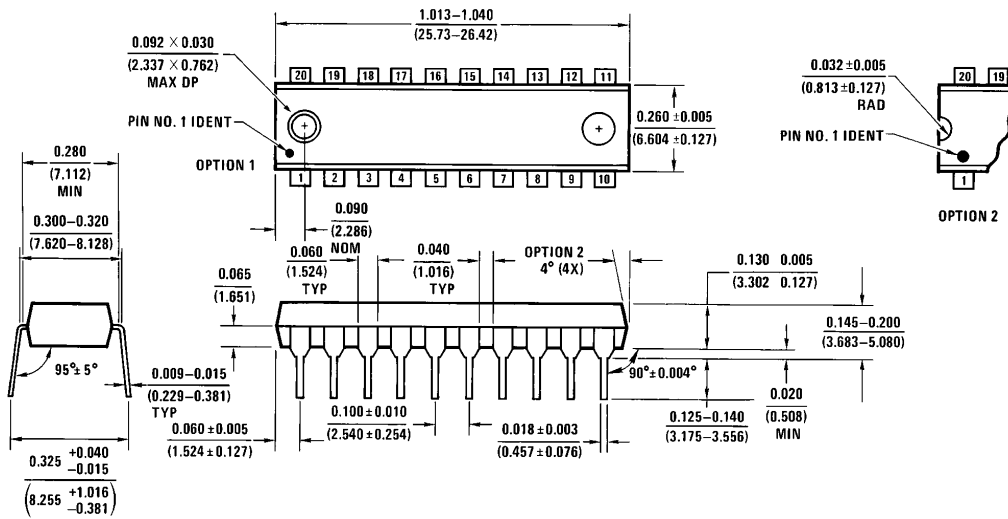

**20-Lead Molded Dual-In-Line Package (N)**  
**Order Number MF10ACN or MF10CCN**  
**NS Package Number N20A**

**LIFE SUPPORT POLICY**

NATIONAL'S PRODUCTS ARE NOT AUTHORIZED FOR USE AS CRITICAL COMPONENTS IN LIFE SUPPORT DEVICES OR SYSTEMS WITHOUT THE EXPRESS WRITTEN APPROVAL OF THE PRESIDENT OF NATIONAL SEMICONDUCTOR CORPORATION. As used herein:

1. Life support devices or systems are devices or systems which, (a) are intended for surgical implant into the body, or (b) support or sustain life, and whose failure to perform, when properly used in accordance with instructions for use provided in the labeling, can be reasonably expected to result in a significant injury to the user.
2. A critical component is any component of a life support device or system whose failure to perform can be reasonably expected to cause the failure of the life support device or system, or to affect its safety or effectiveness.



**National Semiconductor Corporation**  
 1111 West Bardin Road  
 Arlington, TX 76017  
 Tel: 1(800) 272-9959  
 Fax: 1(800) 737-7018

**National Semiconductor Europe**  
 Fax: (+49) 0-180-530 85 86  
 Email: cnjwge@tevm2.nsc.com  
 Deutsch Tel: (+49) 0-180-530 85 85  
 English Tel: (+49) 0-180-532 78 32  
 Français Tel: (+49) 0-180-532 93 58  
 Italiano Tel: (+49) 0-180-534 16 80

**National Semiconductor Hong Kong Ltd.**  
 19th Floor, Straight Block,  
 Ocean Centre, 5 Canton Rd.  
 Tsimshatsui, Kowloon  
 Hong Kong  
 Tel: (852) 2737-1600  
 Fax: (852) 2736-9960

**National Semiconductor Japan Ltd.**  
 Tel: 81-043-299-2309  
 Fax: 81-043-299-2408

National does not assume any responsibility for use of any circuitry described, no circuit patent licenses are implied and National reserves the right at any time without notice to change said circuitry and specifications.

This datasheet has been download from:

[www.datasheetcatalog.com](http://www.datasheetcatalog.com)

Datasheets for electronics components.