

LONGTECH OPTICS

Address: 5F No. 88 Sunban South Road
Jimei North Area Xiamen China.
Tel: +86-592-6060928
Fax: +86-592-6682033
E-mail: zhong@longtech-display.com

SPECIFICATIONS OF LCD MODULE

MODULE NO : LCM2002D3-FL-GBW

DOC.REVISION: 00

	SIGNATURE	DATE
PREPARED BY (RD ENGINEER)	LAN	2011-12-19
CHECKED BY		2011-12-19
APPROVED BY		2011-12-19

DOCUMENT REVISION HISTORY

VERSINO	DATE	DESCRIPTION	CHANGED BY
00	December 19, 2011	First issue	

CONTENTS

Item	Page
Functions & Features	3
Mechanical specifications	3
Dimensional Outline	4
Absolute maximum ratings	5
Block diagram	5
Pin description	5
Contrast adjust	6
Optical characteristics	6
Electrical characteristics	6
Timing Characteristics	7-8
Instruction description	9-12
Display character address code:	12
character pattern	13
Quality Specifications	14--21

1.Features

1. 5x8 dots with cursor
2. Built-in controller (S6A0069 or equivalent)
3. +5V power supply
4. Serial Interface I²C, SPI or RS232/TTL
5. 16characters *2lines display

LCD type	<input type="checkbox"/> TN			
	<input type="checkbox"/> FSTN	<input type="checkbox"/> FSTN Negative		
	<input type="checkbox"/> STN Yellow Green	<input checked="" type="checkbox"/> STN Gray	<input type="checkbox"/> STN Blue Negative	
View direction	<input checked="" type="checkbox"/> 6 O'clock		<input type="checkbox"/> 12 O'clock	
Rear Polarizer	<input type="checkbox"/> Reflective		<input checked="" type="checkbox"/> Transflective	<input type="checkbox"/> Transmissive
Backlight Type	<input checked="" type="checkbox"/> LED Array		<input type="checkbox"/> EL	<input type="checkbox"/> Internal Power
	<input type="checkbox"/> LED Edge		<input type="checkbox"/> CCFL	<input checked="" type="checkbox"/> External Power
Backlight Color	<input type="checkbox"/> White	<input type="checkbox"/> Blue	<input type="checkbox"/> Amber	<input checked="" type="checkbox"/> Yellow-Green
Temperature Range	<input type="checkbox"/> Normal		<input checked="" type="checkbox"/> Wide	<input type="checkbox"/> Super Wide
DC to DC circuit	<input type="checkbox"/> Build-in		<input checked="" type="checkbox"/> Not Build-in	
Touch screen	<input type="checkbox"/> With		<input checked="" type="checkbox"/> Without	
Font type	<input checked="" type="checkbox"/> English-Japanese	<input type="checkbox"/> English-Europen	<input type="checkbox"/> English-Russian	<input type="checkbox"/> Other

2.MECHANICAL SPECIFICATIONS

Module size	116.0mm(L)*37.0mm(W)* Max13.5mm(H)
Viewing area	83.0mm(L)*18.6mm(W)
Character size	3.20mm(L)*5.55mm(W)
Character pitch	3.70mm(L)*5.95mm(W)
Weight	Approx.

3.Outline dimension

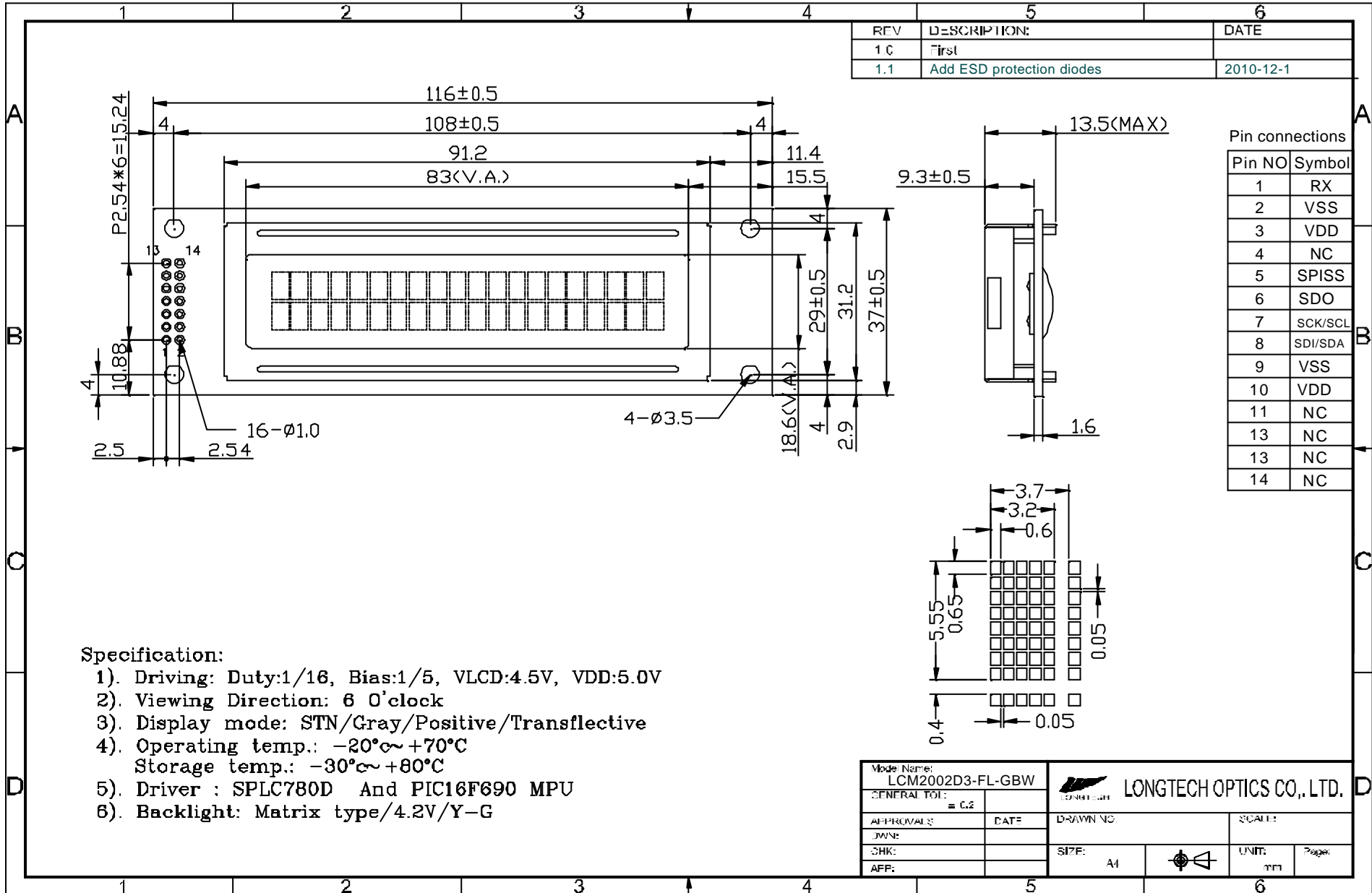

4. Absolute maximum ratings

Item	Symbol	Standard			Unit
Power voltage	$V_{DD}-V_{SS}$	0	-	7.0	V
Input voltage	V_{IN}	VSS	-	VDD	
Operating temperature range	V_{OP}	-20	-	+70	
Storage temperature range	V_{ST}	-30	-	+80	

5. Interface pin description

Pin no.	Symbol	External connection	Function
1	RX	O	RS232 Serial input port
2	V_{SS}	Power supply	Signal ground for LCM (GND)
3	V_{DD}		Power supply for logic (+5V) for LCM
4	SPISS	O	SPI or I2C input port
5	SDO	O	SPI or I2C input port
6	SCK/SCL	O	SPI or I2C input port
7	SDI/SDA	O	SPI or I2C input port
8	V_{SS}	Power supply	Signal ground for LCM (GND)
9	V_{DD}		Power supply for logic (+5V) for LCM

6. Optical characteristics

STN type display module ($T_a=25$, $V_{DD}=5.0V$)

Item	Symbol	Condition	Min.	Typ.	Max.	Unit
Viewing angle		C_r 2	-60	-	35	deg
			-40	-	40	
Contrast ratio	C_r		-	6	-	-
Response time (rise)	T_r	-	-	150	250	ms
Response time (fall)	T_r	-	-	150	250	

7. Electrical characteristics

DC characteristics

Parameter	Symbol	Conditions	Min.	Typ.	Max.	Unit
Supply voltage for LCD	$V_{DD}-V_0$	$T_a=25$	-	4.5	-	V
Input voltage	V_{DD}		4.5	5.0	5.5	
Supply current	I_{DD}	$T_a=25$, $V_{DD}=5.0V$	-	2.0	2.5	mA
Input leakage current	I_{LKG}		-	-	2.0	uA
"H" level input voltage	V_{IH}		2.2	-	V_{DD}	V
"L" level input voltage	V_{IL}	Twice initial value or less	0	-	0.6	
"H" level output voltage	V_{OH}	LOH=-0.25mA	2.4	-	-	
"L" level output voltage	V_{OL}	LOH=1.6mA	-	-	0.4	

8. Communications

I2C Communication

To enter the I²C mode, a jumper is placed on R2 of the interface board and 2 pull-up resistors (nominal value of 1K to 10K Ohm), must be placed on SDA and SCK communication lines, R7 and R8.

The default I²C address is 50 (32 hex). The I²C address can be changed to any 8-bit value by command function, with the exception that the LSB (least significant bit) must always be '0'. Once the I²C address has been changed, it will be saved in the system memory, and it will revert back to the default address if either RS232 or SPI protocol is selected.

The I2C interface is capable of receiving data at up to 400KHz-clock rate.

SPI Communication

To enter the SPI mode, a jumper is placed on R1 of the interface board.

The SPI mode has a normally high level idle clock; data sampled on the rising edge of the clock and Slave Select is enabled.

RS232 Communication

To enter the RS232 mode, both jumpers, R1 and R2 are removed.

The RS232 signal must be 5V, TTL compatible. The communication format is 8-bit data, one stop bit, no parity and no hand shaking. The default BAUD rate is 9600, and it is changeable with a command function, once the BAUD rate is changed, it will be saved in the system memory, and it can be reverted back to default BAUD rate if either I²C or SPI protocol is selected.

Changing the I2C Slave Address

Syntax hexadecimal 0xFE 0x62 [adr]

Parameter	Parameter	Length	Description
[adr]		1 byte	New I ² C address, 0x00 – 0xFE The LSB is always '0'.

Description This command sets the I2C address, the address must be an even number, (LSB = 0). The address change requires 20 microsecond to take effect; therefore, the subsequent input must have an appropriate delay. The default I2C address can be restored if SPI or RS232 is selected as the communication mode.
Default 0x50

Changing BAUD Rate

Syntax hexadecimal 0xFE 0x61 [baud]

Parameter	Parameter	Length	Description
[baud]		1 byte	New RS232 BAUD Rate, 1 - 8

Description This command sets the RS232 BAUD rate, the single byte parameter select the desired BAUD rate as in the table below. The new BAUD rate requires 20 microsecond to take effect, therefore, the subsequent input must have an appropriate delay. The default BAUD rate can be restored if I2C or SPI is selected as the communication mode. Illegal parameter input will be discarded.
Default 9600 BAUD

Parameter	BAUD
1	300
2	1200
3	2400
4	9600
5	14400
6	19.2K
7	57.6K
8	115.2K

9. Build-In Functions

Introduction

There several build-in functions in the serial interface to facilitate the LCD control, These functions eliminate the needs for end user to understand the HD44780 instruction set and timing requirements. It also provides control for features that are not accessible with a serial connection.

Turn On Display

Syntax hexadecimal 0xFE 0x41

Parameter	Parameter	Length	Description
None	None	None	Turn on LCD screen

Description This command turn on the LCD display screen, the display text is not altered.
 Default LCD screen is on

Turn Off Display

Syntax hexadecimal 0xFE 0x42

Parameter	Parameter	Length	Description
None	None	None	Turn off LCD screen

Description This command turn off the LCD display screen, the display text is not altered.
 Default LCD screen is on

Set Cursor Position

Syntax hexadecimal 0xFE 0x45 [pos]

Parameter	Parameter	Length	Description
[pos]	[pos]	1 byte	Put cursor at location specified by [pos], 0x00 to 0x67

Description This command moves the cursor to a specified location where the next character will be displayed. A typical cursor position for a 4-line display is show below; a cursor position outside these ranges will not be viewable.

	Column1	Column20
Line1	0x00	0x13
Line 2	0x40	0x53
Line 3	0x14	0x27
Line 4	0x54	0x67

Default After a reset, the cursor is on position 0x00.

Home Cursor

Syntax hexadecimal 0xFE 0x46

Parameter	Parameter	Length	Description
	None	None	Position cursor at line 1 column 1
Description	This command move the cursor to line 1, column 1 of the LCD screen, the display text is not altered.		
Default	None		

Turn On Underline Cursor

Syntax hexadecimal 0xFE 0x47

Parameter	Parameter	Length	Description
	None	None	Turn on underline cursor

Description This command turn on the underline cursor, the cursor position is where the next character will appear.

Default The underline cursor is off.

Turn Off Underline Cursor

Syntax hexadecimal 0xFE 0x48

Parameter	Parameter	Length	Description
	None	None	Turn off underline cursor

Description This command turn off the underline cursor.

Default The underline cursor is off.

Move Cursor Left One Space

Syntax hexadecimal 0xFE 0x49

Parameter	Parameter	Length	Description
	None	None	Move cursor left 1 space

Description This command move the cursor position left 1 space, regardless the cursor is displayed or not, and the displayed character is not altered

Default None

Move Cursor Right One Space

Syntax hexadecimal 0xFE 0x4A

Parameter	Parameter	Length	Description
	None	None	Move cursor right 1 space

Description This command move the cursor position right 1 space, regardless the cursor is displayed or not, and the displayed character is not altered

Default None

Turn On Blinking Cursor

Syntax hexadecimal 0xFE 0x4B

Parameter	Parameter	Length	Description
	None	None	Turn on the blinking cursor

Description This command turn on the blinking cursor, both the cursor and the character on the cursor will blink.

Default The blinking cursor is off.

Turn Off Blinking Cursor

Syntax hexadecimal 0xFE 0x4C

Parameter	Parameter	Length	Description
	None	None	Turn off the blinking cursor

Description This command turn off the blinking cursor.

Default The blinking cursor is off.

Back Space

Syntax hexadecimal 0xFE 0x4E

Parameter	Parameter	Length	Description
	None	None	Move cursor back one space and delete the character on the cursor.

Description This command is destructive backspace, the cursor is moved back one space and the character on the cursor is deleted.

Default None.

Clear Screen

Syntax hexadecimal 0xFE 0x51

Parameter	Parameter	Length	Description
	None	None	Clear LCD and move cursor to line 1 column 1.

Description This command clears the entire display and place the cursor at line 1 column 1.

Default None.

Set Display Contrast

Syntax hexadecimal 0xFE 0x52 [contrast]

Parameter	Parameter	Length	Description
	[contrast]	1 byte	Set the display contrast, value between 1 to 50

Description This command set the LCD character display contrast, the contrast setting is between 1 to 50, where 50 is the highest contrast.

Default Default contrast value is 40.

Set Backlight Brightness

Syntax hexadecimal 0xFE 0x53 [brightness]

Parameter	Parameter	Length	Description
	[brightness]	1 byte	Set the LCD backlight brightness level, value between 1 to 16

Description This command set the LCD display backlight brightness level, the value is between 1 to 16.

Default Default contrast value is 1.

Load Custom Characters

Syntax hexadecimal 0xFE 0x54 [addr] [d0 ..d7]

Parameter	Parameter	Length	Description
	[addr]	1 byte	Custom character address, 0 – 7
	[D0..D7]	8 bytes	Custom character pattern bit map

Description There are space for eight user defined custom characters, this command load the custom character into one of the eight locations. The custom character pattern is bit mapped into 8 data bytes, the bit map for Spanish character ‘¿’ is shown in table below, to display the custom character, user simply enter the address of the character (0 to 8).

Default None.

Bit	7	6	5	4	3	2	1	0	Hex
Byte 1	0	0	0	0	0	1	0	0	0x04
Byte 2	0	0	0	0	0	0	0	0	0x00
Byte 3	0	0	0	0	0	1	0	0	0x04
Byte 4	0	0	0	0	1	0	0	0	0x08
Byte 5	0	0	0	1	0	0	0	0	0x10
Byte 6	0	0	0	1	0	0	0	1	0x11
Byte 7	0	0	0	0	1	1	1	0	0x0E
Byte 8	0	0	0	0	0	0	0	0	0x00

Shift Display to the Left

Syntax hexadecimal 0xFE 0x55

Parameter	Parameter	Length	Description
	None	None	Shift the LCD screen to the left one Place.

Description This command shift the display one place to the left, the cursor position also moves with the display, and the display data is not altered.

Default None

Shift Display to the Right

Syntax hexadecimal 0xFE 0x56

Parameter	Parameter	Length	Description
	None	None	Shift the LCD screen to the right one Place.

Description This command shift the display one place to the right, the cursor position also moves with the display, and the display data is not altered.

Default None

Display Firmware Version Number

Syntax hexadecimal 0xFE 0x70

Parameter	Parameter	Length	Description
	None	None	Display the firmware version number.

Description This command display the micro-controller firmware version number.

Default None.

Display RS232 Baud Rate

Syntax hexadecimal 0xFE 0x71

Parameter	Parameter	Length	Description
	None	None	Display Baud Rate

Description This command display the current RS232 BAUD rate.

Default None.

Display I²C Address

Syntax hexadecimal 0xFE 0x72

Parameter	Parameter	Length	Description
	None	None	Display I ² C Address

Description This command display the current I²C slave address.

Default None.

Direct HD44780 Command

Syntax	hexadecimal 0xFE 0xFE [cmd]						
Parameter	<table border="1"> <thead> <tr> <th>Parameter</th> <th>Length</th> <th>Description</th> </tr> </thead> <tbody> <tr> <td>[cmd]</td> <td>1 byte</td> <td>Direct interface to the LCD controller, HD44780.</td> </tr> </tbody> </table>	Parameter	Length	Description	[cmd]	1 byte	Direct interface to the LCD controller, HD44780.
Parameter	Length	Description					
[cmd]	1 byte	Direct interface to the LCD controller, HD44780.					
Description	This command is for advanced programmer, it allows LCD instruction to send directly to the SPLC780D controller.						
Default	None.						

ASCII TEXT

To display normal text, just enter its ASCII number, a number from 0x00 to 0x07 displays the user defined custom character, 0x20 to 0x7F displays the stand set of characters. And numbers from 0xA0 to 0xFD display characters and symbols that are factory-masked on the SPLC780D controller and 0xFE is reserved for function command.

Command Summary

Prefix	CMD	Param	Description
0xFE	0x41	None	Display on
0xFE	0x42	None	Display off
0xFE	0x45	1 Byte	Set cursor
0xFE	0x46	None	Cursor home
0xFE	0x47	None	Underline cursor on
0xFE	0x48	None	Underline cursor off
0xFE	0x49	None	Move cursor left one place
0xFE	0x4A	None	Move cursor right one place
0xFE	0x4B	None	Blinking cursor on
0xFE	0x4C	None	Blinking cursor off
0xFE	0x4E	None	Backspace
0xFE	0x51	None	Clear screen
0xFE	0x52	1 Byte	Set contrast
0xFE	0x53	1 Byte	Set backlight brightness
0xFE	0x54	9 Byte	Load custom character
0xFE	0x55	None	Move display one place to the left
0xFE	0x56	None	Move display one place to the right
0xFE	0x61	1 Byte	Change RS232 BAUD rate 232
0xFE	0x62	1 Byte	Change I2C address
0xFE	0x70	None	Display firmware version number
0xFE	0x71	None	Display RS232 BAUD rate
0xFE	0x72	None	Display I2C address
0xFE	0xFE	1 Byte	Send control byte to

10. Standard character pattern

Lower 4 Bits	Upper 4 Bits	0000	0001	0010	0011	0100	0101	0110	0111	1000	1001	1010	1011	1100	1101	1110	1111	
		xxxx0000	CG RAM (1)			0	@	P	`	P					-	9	3	α
xxxx0001	(2)			!	1	A	Q	a	q				。	ア	チ	△	⊙	♀
xxxx0010	(3)			"	2	B	R	b	r				「	イ	ツ	×	ρ	θ
xxxx0011	(4)			#	3	C	S	c	s				」	ウ	テ	モ	ε	%
xxxx0100	(5)			\$	4	D	T	d	t				、	エ	ト	ト	μ	Ω
xxxx0101	(6)			%	5	E	U	e	u				。	オ	ナ	1	θ	ü
xxxx0110	(7)			&	6	F	V	f	v				ヲ	カ	ニ	ヨ	ρ	μ
xxxx0111	(8)			'	7	G	W	g	w				ア	キ	ヌ	ラ	♀	π
xxxx1000	(1)			<	8	H	X	h	x				イ	ク	ネ	リ	√	×
xxxx1001	(2)			>	9	I	Y	i	y				ウ	ケ	ル	ル	ˆ	∫
xxxx1010	(3)			*	:	J	Z	j	z				エ	コ	ハ	レ	∫	κ
xxxx1011	(4)			+	;	K	[k	[オ	サ	ヒ	ロ	°	π
xxxx1100	(5)			,	<	L	¥	l	l				カ	シ	フ	ワ	φ	π
xxxx1101	(6)			-	=	M]	m]				ユ	ス	ハ	シ	κ	÷
xxxx1110	(7)			.	>	N	^	n	^				ヨ	セ	ホ	°	π	
xxxx1111	(8)			/	?	O	_	o	_				ツ	ソ	マ	°	ö	■

11.QUALITY SPECIFICATIONS

11.1 Standard of the product appearance test

Manner of appearance test: The inspection should be performed in using 20W x 2 fluorescent lamps. Distance between LCM and fluorescent lamps should be 100 cm or more. Distance between LCM and inspector eyes should be 30 cm or more.

Viewing direction for inspection is 45° from vertical against LCM.

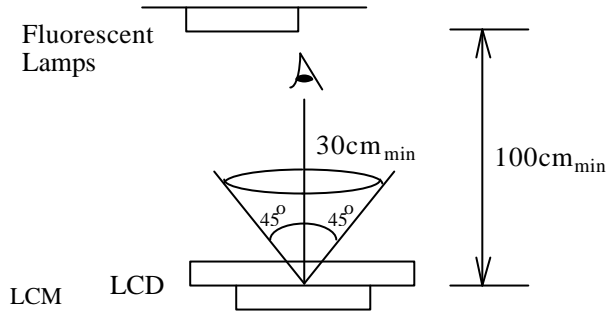

Definition of zone:

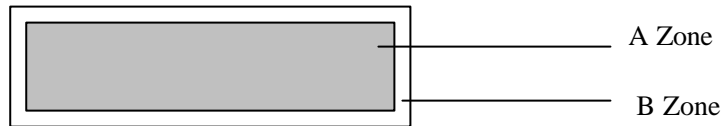

A Zone: Active display area (minimum viewing area).

B Zone: Non-active display area (outside viewing area).

11.2 Specification of quality assurance

AQL inspection standard

Sampling method: MIL-STD-105E, Level II, single sampling

Defect classification **(Note: * is not including)**

Classify	Item		Note	AQL
Major	Display state	Short or open circuit	1	0.65
		LC leakage		
		Flickering		
		No display		
		Wrong viewing direction		
		Contrast defect (dim, ghost)	2	
	Back-light	1,8		
	Non-display	Flat cable or pin reverse	10	
Wrong or missing component		11		
Minor	Display state	Background color deviation	2	1.0
		Black spot and dust	3	
		Line defect, Scratch	4	
		Rainbow	5	
		Chip	6	
		Pin hole	7	
	Polarizer	Protruded	12	
		Bubble and foreign material	3	
	Soldering	Poor connection	9	
	Wire	Poor connection	10	
	TAB	Position, Bonding strength	13	

Note on defect classification

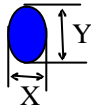
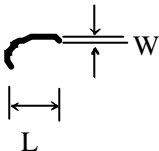
No.	Item	Criterion																				
1	Short or open circuit	Not allow																				
	LC leakage																					
	Flickering																					
	No display																					
	Wrong viewing direction																					
	Wrong Back-light																					
2	Contrast defect	Refer to approval sample																				
	Background color deviation																					
3	Point defect, Black spot, dust (including Polarizer) $\phi = (X+Y)/2$	 <table border="1" data-bbox="863 869 1297 1164"> <thead> <tr> <th>Point Size</th> <th>Acceptable Qty.</th> </tr> </thead> <tbody> <tr> <td>$\phi \leq 0.10$</td> <td>Disregard</td> </tr> <tr> <td>$0.10 < \phi \leq 0.20$</td> <td>3</td> </tr> <tr> <td>$0.20 < \phi \leq 0.25$</td> <td>2</td> </tr> <tr> <td>$0.25 < \phi \leq 0.30$</td> <td>1</td> </tr> <tr> <td>$\phi > 0.30$</td> <td>0</td> </tr> </tbody> </table> <p style="text-align: right;">Unit : mm</p>	Point Size	Acceptable Qty.	$\phi \leq 0.10$	Disregard	$0.10 < \phi \leq 0.20$	3	$0.20 < \phi \leq 0.25$	2	$0.25 < \phi \leq 0.30$	1	$\phi > 0.30$	0								
Point Size	Acceptable Qty.																					
$\phi \leq 0.10$	Disregard																					
$0.10 < \phi \leq 0.20$	3																					
$0.20 < \phi \leq 0.25$	2																					
$0.25 < \phi \leq 0.30$	1																					
$\phi > 0.30$	0																					
4	Line defect, Scratch	 <table border="1" data-bbox="791 1301 1337 1554"> <thead> <tr> <th colspan="2">Line</th> <th>Acceptable Qty.</th> </tr> <tr> <th>L</th> <th>W</th> <th></th> </tr> </thead> <tbody> <tr> <td>---</td> <td>$0.015 \leq W$</td> <td>Disregard</td> </tr> <tr> <td>3.0 L</td> <td>$0.03 \leq W$</td> <td rowspan="2">2</td> </tr> <tr> <td>2.0 L</td> <td>$0.05 \leq W$</td> </tr> <tr> <td>1.0 L</td> <td>$0.1 > W$</td> <td>1</td> </tr> <tr> <td>---</td> <td>$0.05 < W$</td> <td>Applied as point defect</td> </tr> </tbody> </table> <p style="text-align: right;">Unit: mm</p>	Line		Acceptable Qty.	L	W		---	$0.015 \leq W$	Disregard	3.0 L	$0.03 \leq W$	2	2.0 L	$0.05 \leq W$	1.0 L	$0.1 > W$	1	---	$0.05 < W$	Applied as point defect
Line		Acceptable Qty.																				
L	W																					
---	$0.015 \leq W$	Disregard																				
3.0 L	$0.03 \leq W$	2																				
2.0 L	$0.05 \leq W$																					
1.0 L	$0.1 > W$	1																				
---	$0.05 < W$	Applied as point defect																				
5	Rainbow	Not more than two color changes across the viewing area.																				

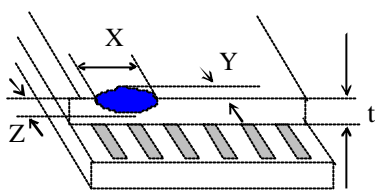
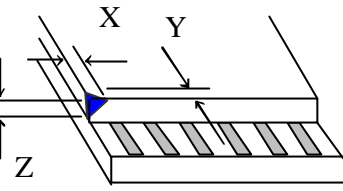
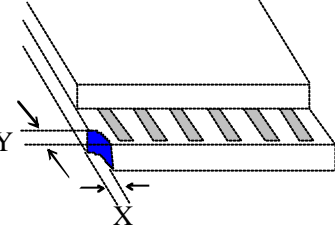
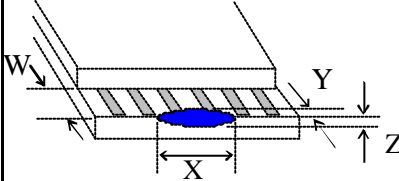
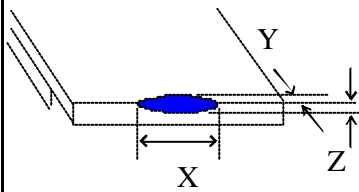
No	Item	Criterion																																	
6	<p>Chip</p> <p>Remark:</p> <p>X: Length direction</p> <p>Y: Short direction</p> <p>Z: Thickness direction</p> <p>t: Glass thickness</p> <p>W: Terminal Width</p>	 <p>Acceptable criterion</p> <table border="1" data-bbox="933 291 1324 369"> <thead> <tr> <th>X</th> <th>Y</th> <th>Z</th> </tr> </thead> <tbody> <tr> <td>2</td> <td>0.5mm</td> <td>t/2</td> </tr> </tbody> </table>  <p>Acceptable criterion</p> <table border="1" data-bbox="917 604 1324 683"> <thead> <tr> <th>X</th> <th>Y</th> <th>Z</th> </tr> </thead> <tbody> <tr> <td>2</td> <td>0.5mm</td> <td>t</td> </tr> </tbody> </table>  <p>Acceptable criterion</p> <table border="1" data-bbox="933 896 1324 1008"> <thead> <tr> <th>X</th> <th>Y</th> <th>Z</th> </tr> </thead> <tbody> <tr> <td>3</td> <td>2</td> <td>t</td> </tr> <tr> <td colspan="2">shall not reach to ITO</td> <td></td> </tr> </tbody> </table>  <p>Acceptable criterion</p> <table border="1" data-bbox="917 1265 1332 1355"> <thead> <tr> <th>X</th> <th>Y</th> <th>Z</th> </tr> </thead> <tbody> <tr> <td>Disregard</td> <td>0.2</td> <td>t</td> </tr> </tbody> </table>  <p>Acceptable criterion</p> <table border="1" data-bbox="917 1556 1292 1635"> <thead> <tr> <th>X</th> <th>Y</th> <th>Z</th> </tr> </thead> <tbody> <tr> <td>5</td> <td>2</td> <td>t/3</td> </tr> </tbody> </table>	X	Y	Z	2	0.5mm	t/2	X	Y	Z	2	0.5mm	t	X	Y	Z	3	2	t	shall not reach to ITO			X	Y	Z	Disregard	0.2	t	X	Y	Z	5	2	t/3
X	Y	Z																																	
2	0.5mm	t/2																																	
X	Y	Z																																	
2	0.5mm	t																																	
X	Y	Z																																	
3	2	t																																	
shall not reach to ITO																																			
X	Y	Z																																	
Disregard	0.2	t																																	
X	Y	Z																																	
5	2	t/3																																	

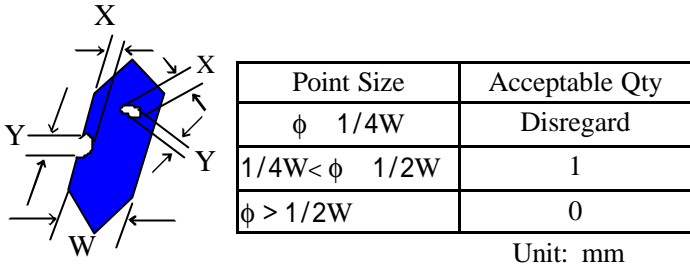
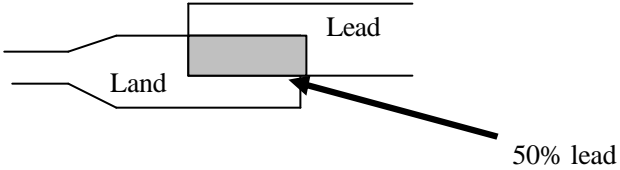
No.	Item	Criterion								
7	Segment pattern $W = \text{Segment width}$ $\phi = (X+Y)/2$	(1) Pin hole $\phi < 0.10\text{mm}$ is acceptable.  <table border="1" data-bbox="853 432 1311 600"> <thead> <tr> <th>Point Size</th> <th>Acceptable Qty</th> </tr> </thead> <tbody> <tr> <td>$\phi < 1/4W$</td> <td>Disregard</td> </tr> <tr> <td>$1/4W < \phi < 1/2W$</td> <td>1</td> </tr> <tr> <td>$\phi > 1/2W$</td> <td>0</td> </tr> </tbody> </table> Unit: mm	Point Size	Acceptable Qty	$\phi < 1/4W$	Disregard	$1/4W < \phi < 1/2W$	1	$\phi > 1/2W$	0
Point Size	Acceptable Qty									
$\phi < 1/4W$	Disregard									
$1/4W < \phi < 1/2W$	1									
$\phi > 1/2W$	0									
8	Back-light	(1) The color of backlight should correspond its specification. (2) Not allow flickering								
9	Soldering	(1) Not allow heavy dirty and solder ball on PCB. (The size of dirty refer to point and dust defect) (2) Over 50% of lead should be soldered on Land. 								
10	Wire	(1) Copper wire should not be rusted (2) Not allow crack on copper wire connection. (3) Not allow reversing the position of the flat cable. (4) Not allow exposed copper wire inside the flat cable.								
11*	PCB	(1) Not allow screw rust or damage. (2) Not allow missing or wrong putting of component.								

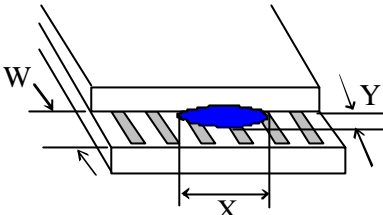
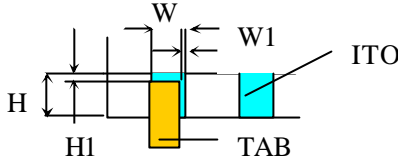
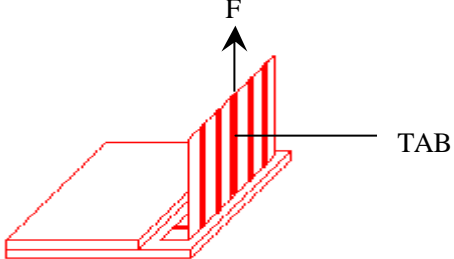
No	Item	Criterion				
12	Protruded W: Terminal Width	 <p>Acceptable criteria: $Y \leq 0.4$</p>				
13	TAB	<p>1. Position</p>  <table border="1" data-bbox="1117 616 1348 750"> <tr> <td>W1</td> <td>1/3W</td> </tr> <tr> <td>H1</td> <td>1/3H</td> </tr> </table> <p>2. TAB bonding strength test</p>  <p> $P (=F/TAB \text{ bonding width})$ 650gf/cm ,(speed rate: 1mm/min) 5pcs per SOA (shipment) </p>	W1	1/3W	H1	1/3H
W1	1/3W					
H1	1/3H					
14	Total no. of acceptable Defect	<p>A. Zone</p> <p>Maximum 2 minor non-conformities per one unit. Defect distance: each point to be separated over 10mm</p> <p>B. Zone</p> <p>It is acceptable when it is no trouble for quality and assembly in customer's end product.</p>				

11.3 Reliability of LCM

Reliability test condition:

Item	Condition	Time (hrs)	Assessment
High temp. Storage	80°C	48	No abnormalities in functions and appearance
High temp. Operating	70°C	48	
Low temp. Storage	-30°C	48	
Low temp. Operating	-20°C	48	
Humidity	40°C/ 90%RH	48	
Temp. Cycle	0°C ← 25°C → 50°C (30 min ← 5 min → 30min)	10cycles	

Recovery time should be 24 hours minimum. Moreover, functions, performance and appearance shall be free from remarkable deterioration within 50,000 hours under ordinary operating and storage conditions room temperature (20±8°C), normal humidity (below 65% RH), and in the area not exposed to direct sun light.

11.4 Precaution for using LCD/LCM

LCD/LCM is assembled and adjusted with a high degree of precision. Do not attempt to make any alteration or modification. The followings should be noted.

General Precautions:

1. LCD panel is made of glass. Avoid excessive mechanical shock or applying strong pressure onto the surface of display area.
2. The polarizer used on the display surface is easily scratched and damaged. Extreme care should be taken when handling. To clean dust or dirt off the display surface, wipe gently with cotton, or other soft material soaked with isopropyl alcohol, ethyl alcohol or trichlorotrifluoroethane, do not use water, ketone or aromatics and never scrub hard.
3. Do not tamper in any way with the tabs on the metal frame.
4. Do not make any modification on the PCB without consulting LONGTECH
5. When mounting a LCM, make sure that the PCB is not under any stress such as bending or twisting. Elastomer contacts are very delicate and missing pixels could result from slight dislocation of any of the elements.
6. Avoid pressing on the metal bezel, otherwise the elastomer connector could be deformed and lose contact, resulting in missing pixels and also cause rainbow on the display.
7. Be careful not to touch or swallow liquid crystal that might leak from a damaged cell. Any liquid crystal adheres to skin or clothes, wash it off immediately with soap and water.

Static Electricity Precautions:

1. CMOS-LSI is used for the module circuit; therefore operators should be grounded whenever he/she comes into contact with the module.
2. Do not touch any of the conductive parts such as the LSI pads; the copper leads on the PCB and the interface terminals with any parts of the human body.
3. Do not touch the connection terminals of the display with bare hand; it will cause disconnection or

defective insulation of terminals.

4. The modules should be kept in anti-static bags or other containers resistant to static for storage.
5. Only properly grounded soldering irons should be used.
6. If an electric screwdriver is used, it should be grounded and shielded to prevent sparks.
7. The normal static prevention measures should be observed for work clothes and working benches.
8. Since dry air is inductive to static, a relative humidity of 50-60% is recommended.

Soldering Precautions:

1. Soldering should be performed only on the I/O terminals.
2. Use soldering irons with proper grounding and no leakage.
3. Soldering temperature: $280^{\circ}\text{C}\pm 10^{\circ}\text{C}$
4. Soldering time: 3 to 4 second.
5. Use eutectic solder with resin flux filling.
6. If flux is used, the LCD surface should be protected to avoid spattering flux.
7. Flux residue should be removed.

Operation Precautions:

1. The viewing angle can be adjusted by varying the LCD driving voltage V_o .
2. Since applied DC voltage causes electro-chemical reactions, which deteriorate the display, the applied pulse waveform should be a symmetric waveform such that no DC component remains. Be sure to use the specified operating voltage.
3. Driving voltage should be kept within specified range; excess voltage will shorten display life.
4. Response time increases with decrease in temperature.
5. Display color may be affected at temperatures above its operational range.
6. Keep the temperature within the specified range usage and storage. Excessive temperature and humidity could cause polarization degradation, polarizer peel-off or generate bubbles.
7. For long-term storage over 40°C is required, the relative humidity should be kept below 60%, and avoid direct sunlight.

Limited Warranty

LONGTECH LCDs and modules are not consumer products, but may be incorporated by LONGTECH's customers into consumer products or components thereof, LONGTECH does not warrant that its LCDs and components are fit for any such particular purpose.

1. The liability of LONGTECH is limited to repair or replacement on the terms set forth below. LONGTECH will not be responsible for any subsequent or consequential events or injury or damage to any personnel or user including third party personnel and/or user. Unless otherwise agreed in writing between LONGTECH and the customer, LONGTECH will only replace or repair any of its LCD which is found defective electrically or visually when inspected in accordance with LONGTECH general LCD inspection standard . (Copies available on request)
2. No warranty can be granted if any of the precautions state in handling liquid crystal display above has been disregarded. Broken glass, scratches on polarizer mechanical damages as well as defects that are caused accelerated environment tests are excluded from warranty.
3. In returning the LCD/LCM, they must be properly packaged; there should be detailed description of the failures or defect.