

CMOS 4-Bit D-Type Registers

High-Voltage Types (20-Volt Rating)

■ CD4076B types are four-bit registers consisting of D-type flip-flops that feature three-state outputs. Data Disable inputs are provided to control the entry of data into the flip-flops. When both Data Disable inputs are low, data at the D inputs are loaded into their respective flip-flops on the next positive transition of the clock input. Output Disable inputs are also provided. When the Output Disable inputs are both low, the normal logic states of the four outputs are available to the load. The outputs are disabled independently of the clock by a high logic level at either Output Disable input, and present a high impedance.

The CD4076B types are supplied in 16-lead ceramic dual-in-line packages (D and F suffixes), 16-lead dual-in-line plastic packages (E suffix), and in chip form (H suffix).

Features:

- Three-state outputs
- Input disabled without gating the clock
- Gated output control lines for enabling or disabling the outputs
- Standardized, symmetrical output characteristics
- 100% tested for quiescent current at 20 V
- Maximum input current of 1 μ A at 18 V over full package temperature range; 100 nA at 18 V and 25°C
- Noise margin over full package temperature range:
 - 1 V at $V_{DD} = 5$ V
 - 2 V at $V_{DD} = 10$ V
 - 2.5 V at $V_{DD} = 15$ V
- 5-V, 10-V, and 15-V parametric ratings
- Meets all requirements of JEDEC Tentative Standard No. 13B, "Standard Specifications for Description of 'B' Series CMOS Devices"

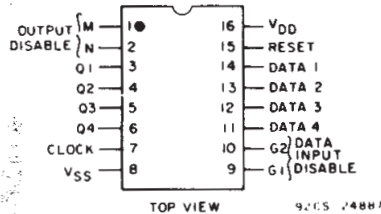

TERMINAL ASSIGNMENT

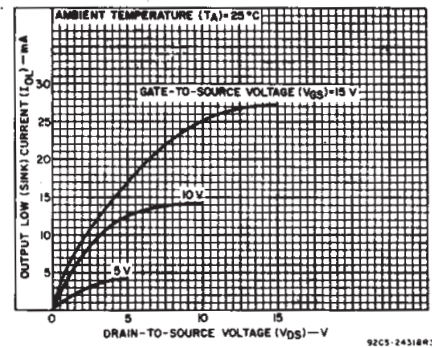
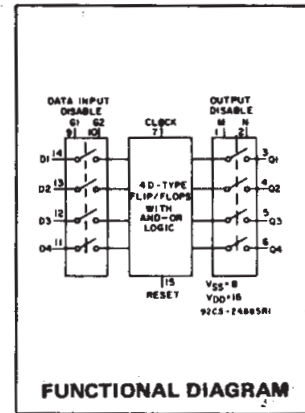

Fig.1 - Typical output low (sink) current characteristics.

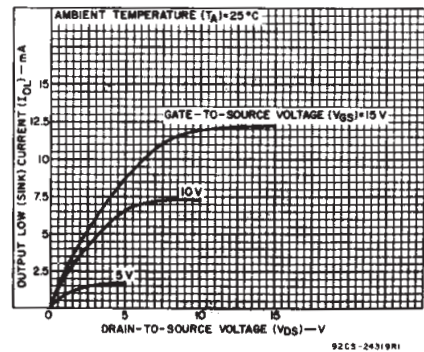

Fig.2 - Minimum output low (sink) current characteristics.

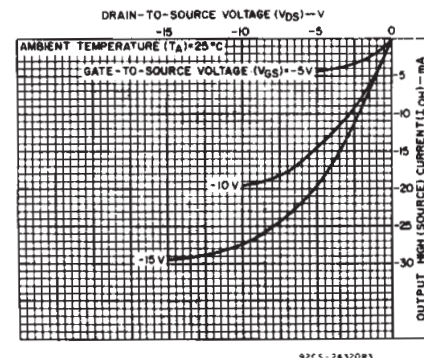

Fig.3 - Typical output high (source) current characteristics.

RECOMMENDED OPERATING CONDITIONS at $T_A = 25^\circ\text{C}$, Except as Noted.
For maximum reliability, normal operating conditions should be selected so that operation is always within the following ranges:

CHARACTERISTIC	V_{DD} (V)	LIMITS		UNITS
		Min.	Max.	
Supply Voltage Range (For T_A = Full Package Temperature Range)		3	18	V
Data Setup Time, t_S	5	200	—	ns
	10	80	—	
	15	60	—	
Clock Pulse Width, t_W	5	200	—	ns
	10	100	—	
	15	80	—	
Clock Input Frequency, f_{CL}	5	—	3	MHz
	10	dc	6	
	15	—	8	
Clock Input Rise or Fall Time, t_{rCL}, t_{fCL}	5	—	15	μ s
	10	—	5	
	15	—	5	
Reset Pulse Width, t_W	5	120	—	ns
	10	50	—	
	15	40	—	
Data Input Disable Setup Time, t_S	5	180	—	ns
	10	100	—	
	15	70	—	

CD4076B Types

MAXIMUM RATINGS, Absolute-Maximum Values:

DC SUPPLY-VOLTAGE RANGE, (V _{DD})	-0.5V to +20V
Voltages referenced to V _{SS} Terminal	
INPUT VOLTAGE RANGE, ALL INPUTS	-0.5V to V _{DD} +0.5V
DC INPUT CURRENT, ANY ONE INPUT	±10mA
POWER DISSIPATION PER PACKAGE (P _D):	
For T _A = -55°C to +100°C	500mW
For T _A = +100°C to +125°C	Derate Linearly at 12mW/°C to 200mW
DEVICE DISSIPATION PER OUTPUT TRANSISTOR	
FOR T _A = FULL PACKAGE-TEMPERATURE RANGE (All Package Types)	100mW
OPERATING-TEMPERATURE RANGE (T _A)	-55°C to +125°C
STORAGE TEMPERATURE RANGE (T _{stg})	-65°C to +150°C
LEAD TEMPERATURE (DURING SOLDERING):	
At distance 1/16 ± 1/32 inch (1.59 ± 0.79mm) from case for 10s max	+265°C

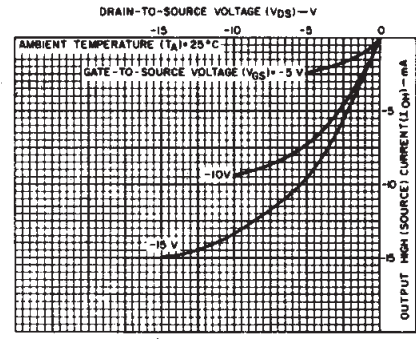
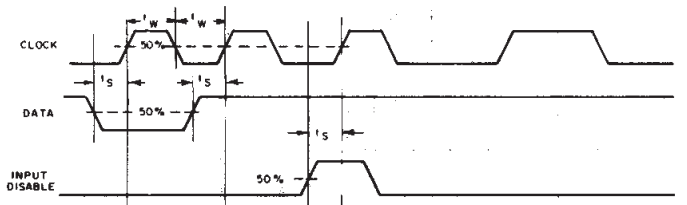
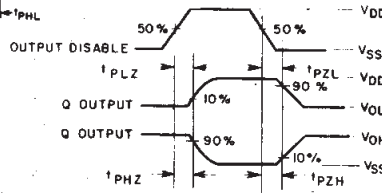

Fig.4 - Minimum output high (source) current characteristics.



(a)



(b)

CHAR.	TEST	VOLT.
	AT D	AT Q
t _{PHZ}	V _{DD}	V _{SS}
t _{PLZ}	V _{SS}	V _{DD}
t _{PZH}	V _{DD}	V _{SS}

Fig.5 - Functional waveforms for CD4076B.

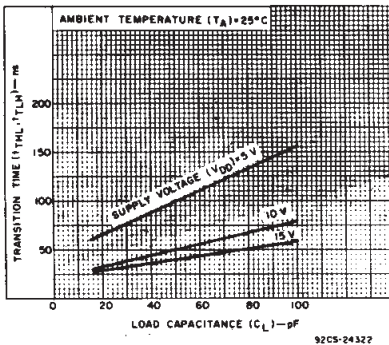

Fig.7 - Typical transition time vs. load capacitance.

Truth Table

Reset	Clock	Data Input Disable G1	Data Input Disable G2	Data D	Next State Output Q
1	X	X	X	X	0
0	0	X	X	X	Q
0	1	1	X	X	Q
0	1	X	1	X	Q
0	0	0	0	1	1
0	0	0	0	0	0
0	1	X	X	X	Q
0	0	X	X	X	Q

When either Output Disable M or N is high, the outputs are disabled (high impedance state), however sequential operation of the flip flops is not affected.

1 = High Level
0 = Low Level
X = Don't Care
NC = No Change

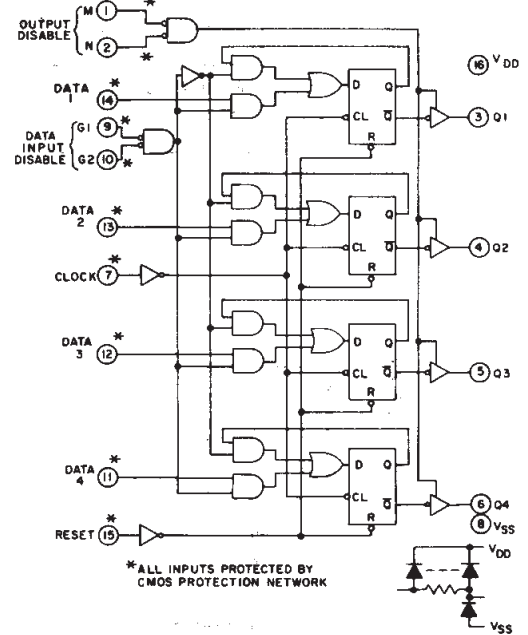

Fig.8 - CD4076B logic diagram.

3
COMMERCIAL CMOS
HIGH VOLTAGE ICs

CD4076B Types

DYNAMIC ELECTRICAL CHARACTERISTICS at $T_A = 25^\circ\text{C}$, Input $t_r, t_f = 20 \text{ ns}$, $C_L = 50 \text{ pF}$, $R_L = 200 \text{ k}\Omega$ (Unless otherwise noted)

CHARACTERISTIC	TEST CONDITIONS	LIMITS			UNITS	
		V_{DD} V	Min.	Typ.		Max.
Propagation Delay Time: Clock to Q Output, t_{PHL} , t_{PLH}		5		300	600	
		10		125	250	
		15		90	180	
Reset, t_{PHL}		5		230	460	ns
		10		100	200	
		15		75	150	
3-State Output 1 or 0 to High Impedance, t_{PHZ} , t_{PLZ}	$R_L = 1 \text{ k}\Omega$	5		150	300	
		10		75	150	
		15		60	120	
3-State High Impedance to 1 or 0 Output, t_{PZH} , t_{PZL}	$R_L = 1 \text{ k}\Omega$	5		150	300	
		10		75	150	
		15		60	120	
Transition Time, t_{THL} , t_{TLH}		5		100	200	ns
		10		50	100	
		15		40	80	
Maximum Clock Input Frequency, f_{CL}		5	3	6		MHz
		10	6	12		
		15	8	16		
Minimum Clock Pulse Width, t_W		5		100	200	ns
		10		50	100	
		15		40	80	
Maximum Clock Input Rise or Fall Time, t_{rcl} , t_{fcl}		5	15	-	-	μs
		10	5	-	-	
		15	5	-	-	
Minimum Reset Pulse Width, t_W		5	-	60	120	ns
		10	-	25	50	
		15	-	20	40	
Minimum Data Setup Time, t_S		5	-	100	200	ns
		10	-	40	80	
		15	-	30	60	
Minimum Data Input Disable Setup Time, t_S		5	-	90	180	ns
		10	-	50	100	
		15	-	35	70	
Input Capacitance, C_{IN}	Any Input	-	-	5	7.5	pF

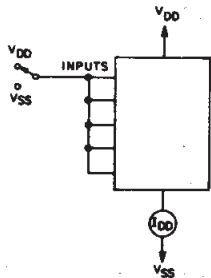

Fig. 11 - Quiescent device current test circuit.

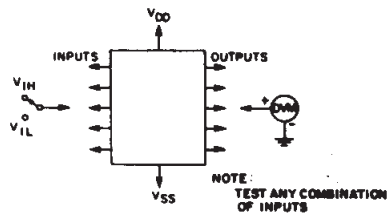

Fig. 12 - Input voltage test circuit.

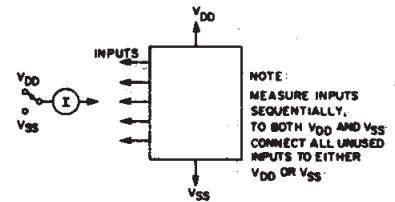

Fig. 13 - Input current test circuit.

CD4076B Types

STATIC ELECTRICAL CHARACTERISTICS

CHARACTERISTIC	CONDITIONS			LIMITS AT INDICATED TEMPERATURES (°C)							UNITS
	V _O (V)	V _{IN} (V)	V _{DD} (V)	-55	-40	+85	+125	+25			
								Min.	Typ.	Max.	
Quiescent Device Current, I _{DD} Max.	—	0,5	5	5	5	150	150	—	0,04	5	μA
	—	0,10	10	10	10	300	300	—	0,04	10	
	—	0,15	15	20	20	600	800	—	0,04	20	
	—	0,20	20	100	100	3000	3000	—	0,08	100	
Output Low (Sink) Current I _{OL} Min.	0,4	0,5	5	0,64	0,61	0,42	0,36	0,51	1	—	mA
	0,5	0,10	10	1,6	1,5	1,1	0,9	1,3	2,6	—	
	1,5	0,15	15	4,2	4	2,8	2,4	3,4	6,8	—	
Output High (Source) Current, I _{OH} Min.	4,6	0,5	5	-0,64	-0,61	-0,42	-0,36	-0,51	-1	—	mA
	2,5	0,5	5	-2	-1,8	-1,3	-1,15	-1,6	-3,2	—	
	9,5	0,10	10	-1,6	-1,5	-1,1	-0,9	-1,3	-2,6	—	
	13,5	0,15	15	-4,2	-4	-2,8	-2,4	-3,4	-6,8	—	
Output Voltage: Low-Level, V _{OL} Max.	—	0,5	5	0,05				—	0	0,05	V
	—	0,10	10	0,05				—	0	0,05	
	—	0,15	15	0,05				—	0	0,05	
Output Voltage: High-Level, V _{OH} Min.	—	0,5	5	4,95				4,95	5	—	V
	—	0,10	10	9,95				9,95	10	—	
	—	0,15	15	14,95				14,95	15	—	
Input Low Voltage, V _{IL} Max.	0,5, 4,5	—	5	1,5				—	—	1,5	V
	1,9	—	10	3				—	—	3	
	1,5, 13,5	—	15	4				—	—	4	
Input High Voltage, V _{IH} Min.	0,5, 4,5	—	5	3,5				3,5	—	—	V
	1,9	—	10	7				7	—	—	
	1,5, 13,5	—	15	11				11	—	—	
Input Current I _{IN} Max.	—	0,18	18	±0,1	±0,1	±1	±1	—	±10 ⁻⁵	±0,1	μA
3-State Output Leakage Current I _{OUT} Max.	0,18	0,18	18	±0,4	±0,4	±12	±12	—	±10 ⁻⁴	±0,4	μA

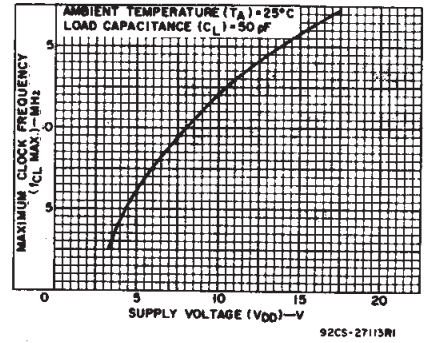

Fig.9 — Typical maximum clock input frequency vs. supply voltage.

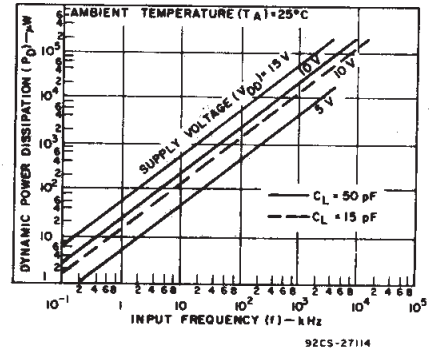
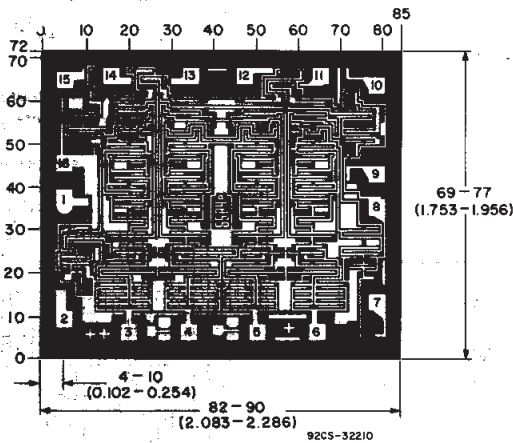

Fig.10 — Typical dynamic power dissipation vs. frequency.



Dimensions and pad layout for CD4076BH

Dimensions in parentheses are in millimeters and are derived from the basic inch dimensions as indicated. Grid graduations are in mils (10⁻³ inch).

3
COMMERCIAL CMOS
HIGH VOLTAGE ICs

IMPORTANT NOTICE

Texas Instruments and its subsidiaries (TI) reserve the right to make changes to their products or to discontinue any product or service without notice, and advise customers to obtain the latest version of relevant information to verify, before placing orders, that information being relied on is current and complete. All products are sold subject to the terms and conditions of sale supplied at the time of order acknowledgement, including those pertaining to warranty, patent infringement, and limitation of liability.

TI warrants performance of its semiconductor products to the specifications applicable at the time of sale in accordance with TI's standard warranty. Testing and other quality control techniques are utilized to the extent TI deems necessary to support this warranty. Specific testing of all parameters of each device is not necessarily performed, except those mandated by government requirements.

CERTAIN APPLICATIONS USING SEMICONDUCTOR PRODUCTS MAY INVOLVE POTENTIAL RISKS OF DEATH, PERSONAL INJURY, OR SEVERE PROPERTY OR ENVIRONMENTAL DAMAGE ("CRITICAL APPLICATIONS"). TI SEMICONDUCTOR PRODUCTS ARE NOT DESIGNED, AUTHORIZED, OR WARRANTED TO BE SUITABLE FOR USE IN LIFE-SUPPORT DEVICES OR SYSTEMS OR OTHER CRITICAL APPLICATIONS. INCLUSION OF TI PRODUCTS IN SUCH APPLICATIONS IS UNDERSTOOD TO BE FULLY AT THE CUSTOMER'S RISK.

In order to minimize risks associated with the customer's applications, adequate design and operating safeguards must be provided by the customer to minimize inherent or procedural hazards.

TI assumes no liability for applications assistance or customer product design. TI does not warrant or represent that any license, either express or implied, is granted under any patent right, copyright, mask work right, or other intellectual property right of TI covering or relating to any combination, machine, or process in which such semiconductor products or services might be or are used. TI's publication of information regarding any third party's products or services does not constitute TI's approval, warranty or endorsement thereof.