

CD4046BC Micropower Phase-Locked Loop

General Description

The CD4046BC micropower phase-locked loop (PLL) consists of a low power, linear, voltage-controlled oscillator (VCO), a source follower, a zener diode, and two phase comparators. The two phase comparators have a common signal input and a common comparator input. The signal input can be directly coupled for a large voltage signal, or capacitively coupled to the self-biasing amplifier at the signal input for a small voltage signal.

Phase comparator I, an exclusive OR gate, provides a digital error signal (phase comp. I Out) and maintains 90° phase shifts at the VCO center frequency. Between signal input and comparator input (both at 50% duty cycle), it may lock onto the signal input frequencies that are close to harmonics of the VCO center frequency.

Phase comparator II is an edge-controlled digital memory network. It provides a digital error signal (phase comp. II Out) and lock-in signal (phase pulses) to indicate a locked condition and maintains a 0° phase shift between signal input and comparator input.

The linear voltage-controlled oscillator (VCO) produces an output signal (VCO Out) whose frequency is determined by the voltage at the VCO_{IN} input, and the capacitor and resistors connected to pin C1_A, C1_B, R1 and R2.

The source follower output of the VCO_{IN} (demodulator Out) is used with an external resistor of 10 kΩ or more.

The INHIBIT input, when high, disables the VCO and source follower to minimize standby power consumption. The zener diode is provided for power supply regulation, if necessary.

Features

- Wide supply voltage range: 3.0V to 18V
- Low dynamic power consumption: 70 μW (typ.) at f_o = 10 kHz, V_{DD} = 5V
- VCO frequency: 1.3 MHz (typ.) at V_{DD} = 10V
- Low frequency drift: 0.06%/°C at V_{DD} = 10V with temperature
- High VCO linearity: 1% (typ.)

Applications

- FM demodulator and modulator
- Frequency synthesis and multiplication
- Frequency discrimination
- Data synchronization and conditioning
- Voltage-to-frequency conversion
- Tone decoding
- FSK modulation
- Motor speed control

Ordering Code:

| Order Number | Package Number | Package Description |
|--------------|----------------|---|
| CD4046BCM | M16A | 16-Lead Small Outline integrated Circuit (SOIC), JEDEC MS-012, 0.150" Narrow Body |
| CD4046BCN | N16E | 16-Lead Plastic Dual-In-Line Package (PDIP), JEDEC MS-001, 0.300" Wide |

Devices also available in Tape and Reel. Specify by appending the suffix letter "X" to the ordering code.

Connection Diagram

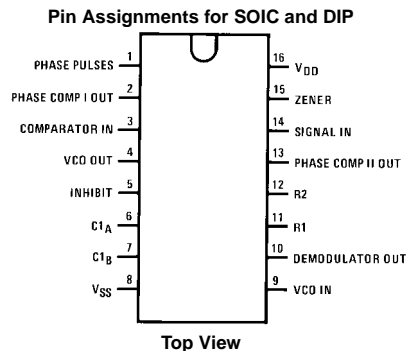

Block Diagram

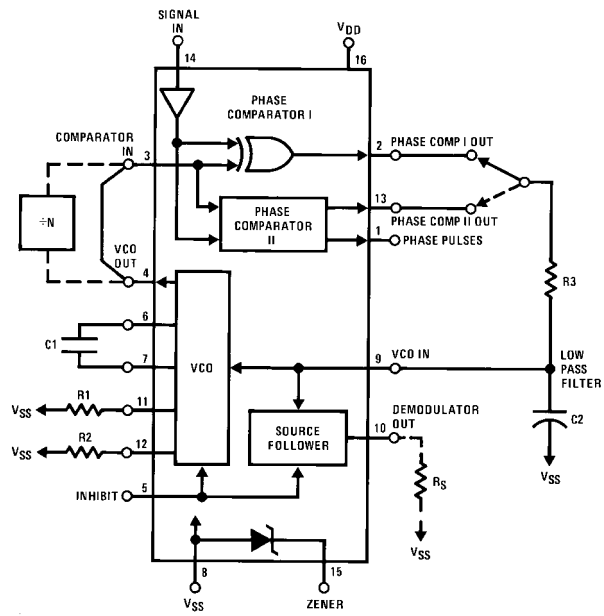

FIGURE 1.

| | | | |
|--|-------------------------------|---|----------------------|
| Absolute Maximum Ratings (Note 1) | | Recommended Operating Conditions (Note 2) | |
| (Note 2) | | | |
| DC Supply Voltage (V_{DD}) | -0.5 to +18 V_{DC} | DC Supply Voltage (V_{DD}) | 3 to 15 V_{DC} |
| Input Voltage (V_{IN}) | -0.5 to $V_{DD} + 0.5 V_{DC}$ | Input Voltage (V_{IN}) | 0 to $V_{DD} V_{DC}$ |
| Storage Temperature Range (T_S) | -65°C to +150°C | Operating Temperature Range (T_A) | -40°C to +85°C |
| Power Dissipation (P_D) | | Note 1: "Absolute Maximum Ratings" are those values beyond which the safety of the device cannot be guaranteed. They are not meant to imply that the devices should be operated at these limits. The table of "Recommended Operating Conditions" and "Electrical Characteristics" provides conditions for actual device operation. | |
| Dual-In-Line | 700 mW | Note 2: $V_{SS} = 0V$ unless otherwise specified. | |
| Small Outline | 500 mW | | |
| Lead Temperature (T_L) | | | |
| (Soldering, 10 seconds) | 260°C | | |

DC Electrical Characteristics (Note 2)

| Symbol | Parameter | Conditions | -40°C | | +25°C | | | +85°C | | Units |
|----------|--|--|-------|------|-------|------------|------|---------|---------|-------|
| | | | Min | Max | Min | Typ | Max | Min | Max | |
| I_{DD} | Quiescent Device Current | Pin 5 = V_{DD} , Pin 14 = V_{DD} , Pin 3, 9 = V_{SS} $V_{DD} = 5V$ | | 20 | 0.005 | 20 | | 150 | μA | |
| | | $V_{DD} = 10V$ | | 40 | 0.01 | 40 | | 300 | μA | |
| | | $V_{DD} = 15V$ | | 80 | 0.015 | 80 | | 600 | μA | |
| | | Pin 5 = V_{DD} , Pin 14 = Open, Pin 3, 9 = V_{SS} $V_{DD} = 5V$ | | 70 | 5 | 55 | | 205 | μA | |
| | $V_{DD} = 10V$ | | 530 | 20 | 410 | | 710 | μA | | |
| | $V_{DD} = 15V$ | | 1500 | 50 | 1200 | | 1800 | μA | | |
| V_{OL} | LOW Level Output Voltage | $V_{DD} = 5V$ | | 0.05 | 0 | 0.05 | | 0.05 | V | |
| | | $V_{DD} = 10V$ | | 0.05 | 0 | 0.05 | | 0.05 | V | |
| | | $V_{DD} = 15V$ | | 0.05 | 0 | 0.05 | | 0.05 | V | |
| V_{OH} | HIGH Level Output Voltage | $V_{DD} = 5V$ | 4.95 | | 4.95 | 5 | | 4.95 | V | |
| | | $V_{DD} = 10V$ | 9.95 | | 9.95 | 10 | | 9.95 | V | |
| | | $V_{DD} = 15V$ | 14.95 | | 14.95 | 15 | | 14.95 | V | |
| V_{IL} | LOW Level Input Voltage Comparator and Signal In | $V_{DD} = 5V, V_O = 0.5V$ or $4.5V$ | | 1.5 | | 2.25 | 1.5 | | 1.5 | V |
| | | $V_{DD} = 10V, V_O = 1V$ or $9V$ | | 3.0 | | 4.5 | 3.0 | | 3.0 | V |
| | | $V_{DD} = 15V, V_O = 1.5V$ or $13.5V$ | | 4.0 | | 6.25 | 4.0 | | 4.0 | V |
| V_{IH} | HIGH Level Input Voltage Comparator and Signal In | $V_{DD} = 5V, V_O = 0.5V$ or $4.5V$ | 3.5 | | 3.5 | 2.75 | | 3.5 | V | |
| | | $V_{DD} = 10V, V_O = 1V$ or $9V$ | 7.0 | | 7.0 | 5.5 | | 7.0 | V | |
| | | $V_{DD} = 15V, V_O = 1.5V$ or $13.5V$ | 11.0 | | 11.0 | 8.25 | | 11.0 | V | |
| I_{OL} | LOW Level Output Current (Note 4) | $V_{DD} = 5V, V_O = 0.4V$ | 0.52 | | 0.44 | 0.88 | | 0.36 | mA | |
| | | $V_{DD} = 10V, V_O = 0.5V$ | 1.3 | | 1.1 | 2.25 | | 0.9 | mA | |
| | | $V_{DD} = 15V, V_O = 1.5V$ | 3.6 | | 3.0 | 8.8 | | 2.4 | mA | |
| I_{OH} | HIGH Level Output Current (Note 4) | $V_{DD} = 5V, V_O = 4.6V$ | -0.52 | | -0.44 | -0.88 | | -0.36 | mA | |
| | | $V_{DD} = 10V, V_O = 9.5V$ | -1.3 | | -1.1 | -2.25 | | -0.9 | mA | |
| | | $V_{DD} = 15V, V_O = 13.5V$ | -3.6 | | -3.0 | -8.8 | | -2.4 | mA | |
| I_{IN} | Input Current | All Inputs Except Signal Input $V_{DD} = 15V, V_{IN} = 0V$ | | -0.3 | | -10^{-5} | -0.3 | | μA | |
| | | $V_{DD} = 15V, V_{IN} = 15V$ | | 0.3 | | 10^{-5} | 0.3 | | μA | |
| C_{IN} | Input Capacitance | Any Input (Note 3) | | | | | 7.5 | | pF | |
| P_T | Total Power Dissipation | $f_o = 10$ kHz, $R1 = 1$ M Ω , $R2 = \infty, cXO_{IN} = c_{\Delta\Delta}/2$ $V_{DD} = 5V$ | | | | 0.07 | | | mW | |
| | | $V_{DD} = 10V$ | | | | 0.6 | | | mW | |
| | | $V_{DD} = 15V$ | | | | 2.4 | | | mW | |

Note 3: Capacitance is guaranteed by periodic testing.

Note 4: I_{OH} and I_{OL} are tested one output at a time.

| AC Electrical Characteristics (Note 5) | | | | | | | | |
|---|--|--|--|--|--|---|--|--|
| $T_A = 25^\circ\text{C}$, $C_L = 50\text{ pF}$ | | | | | | | | |
| Symbol | Parameter | Conditions | Min | Typ | Max | Units | | |
| VCO SECTION | | | | | | | | |
| I_{DD} | Operating Current | $f_o = 10\text{ kHz}$, $R1 = 1\text{ M}\Omega$, $R2 = \infty$, $\zeta X_{OIN} = \zeta_{\Delta\Delta}/2$ $V_{DD} = 5\text{V}$ $V_{DD} = 10\text{V}$ $V_{DD} = 15\text{V}$ | | 20 90 200 | | μA μA μA | | |
| f_{MAX} | Maximum Operating Frequency | $C1 = 50\text{ pF}$, $R1 = 10\text{ k}\Omega$, $R2 = \infty$, $\zeta X_{OIN} = \zeta_{\Delta\Delta}$ $V_{DD} = 5\text{V}$ $V_{DD} = 10\text{V}$ $V_{DD} = 15\text{V}$ | 0.4 0.6 1.0 | 0.8 1.2 1.6 | | MHz MHz MHz | | |
| | Linearity | $V_{COIN} = 2.5\text{V} \pm 0.3\text{V}$, $R1 \geq 10\text{ k}\Omega$, $V_{DD} = 5\text{V}$ $V_{COIN} = 5\text{V} \pm 2.5\text{V}$, $R1 \geq 400\text{ k}\Omega$, $V_{DD} = 10\text{V}$ $V_{COIN} = 7.5\text{V} \pm 5\text{V}$, $R1 \geq 1\text{ M}\Omega$, $V_{DD} = 15\text{V}$ | | 1 1 1 | | % % % | | |
| | | Temperature-Frequency Stability No Frequency Offset, $f_{MIN} = 0$ | $\%/\text{C} < 1/\phi \cdot \zeta_{\Delta\Delta}$ $R2 = \infty$ $V_{DD} = 5\text{V}$ $V_{DD} = 10\text{V}$ $V_{DD} = 15\text{V}$ | | 0.12–0.24 0.04–0.08 0.015–0.03 | | $\%/\text{C}$ $\%/\text{C}$ $\%/\text{C}$ | |
| | | | Frequency Offset, $f_{MIN} \neq 0$ | $V_{DD} = 5\text{V}$ $V_{DD} = 10\text{V}$ $V_{DD} = 15\text{V}$ | | 0.06–0.12 0.05–0.1 0.03–0.06 | | $\%/\text{C}$ $\%/\text{C}$ $\%/\text{C}$ |
| | V_{COIN} | | | Input Resistance $V_{DD} = 5\text{V}$ $V_{DD} = 10\text{V}$ $V_{DD} = 15\text{V}$ | | 10^6 10^6 10^6 | | $\text{M}\Omega$ $\text{M}\Omega$ $\text{M}\Omega$ |
| VCO | | Output Duty Cycle $V_{DD} = 5\text{V}$ $V_{DD} = 10\text{V}$ $V_{DD} = 15\text{V}$ | | | | 50 50 50 | | % % % |
| | | | t_{THL} | | VCO Output Transition Time $V_{DD} = 5\text{V}$ $V_{DD} = 10\text{V}$ $V_{DD} = 15\text{V}$ | | 90 50 45 | 200 100 80 |
| | PHASE COMPARATORS SECTION | | | | | | | |
| R_{IN} | Input Resistance Signal Input $V_{DD} = 5\text{V}$ $V_{DD} = 10\text{V}$ $V_{DD} = 15\text{V}$ | | | 1 0.2 0.1 | | 3 0.7 0.3 | | $\text{M}\Omega$ $\text{M}\Omega$ $\text{M}\Omega$ |
| | | Comparator Input $V_{DD} = 5\text{V}$ $V_{DD} = 10\text{V}$ $V_{DD} = 15\text{V}$ | | | 10^6 10^6 10^6 | | $\text{M}\Omega$ $\text{M}\Omega$ $\text{M}\Omega$ | |
| | | | AC-Coupled Signal Input Voltage Sensitivity $C_{SERIES} = 1000\text{ pF}$ $f = 50\text{ kHz}$ $V_{DD} = 5\text{V}$ $V_{DD} = 10\text{V}$ $V_{DD} = 15\text{V}$ | | | 200 400 700 | 400 800 1400 | mV mV mV |

AC Electrical Characteristics (Continued)

| Symbol | Parameter | Conditions | Min | Typ | Max | Units |
|---|--------------------------|--|-----|------|-----|-------|
| DEMODULATOR OUTPUT | | | | | | |
| VCO _{IN} - V _{DEM} | Offset Voltage | RS ≥ 10 kΩ, V _{DD} = 5V | | 1.50 | 2.2 | V |
| | | RS ≥ 10 kΩ, V _{DD} = 10V | | 1.50 | 2.2 | V |
| | | RS ≥ 50 kΩ, V _{DD} = 15V | | 1.50 | 2.2 | V |
| | Linearity | RS ≥ 50 kΩ | | | | |
| | | VCO _{IN} = 2.5V ±0.3V, V _{DD} = 5V | | 0.1 | | % |
| | | VCO _{IN} = 5V ±2.5V, V _{DD} = 10V | | 0.6 | | % |
| | | VCO _{IN} = 7.5V ±5V, V _{DD} = 15V | | 0.8 | | % |
| ZENER DIODE | | | | | | |
| V _Z | Zener Diode Voltage | I _Z = 50 μA | 6.3 | 7.0 | 7.7 | V |
| R _Z | Zener Dynamic Resistance | I _Z = 1 mA | | 100 | | Ω |

Note 5: AC Parameters are guaranteed by DC correlated testing.

Phase Comparator State Diagrams

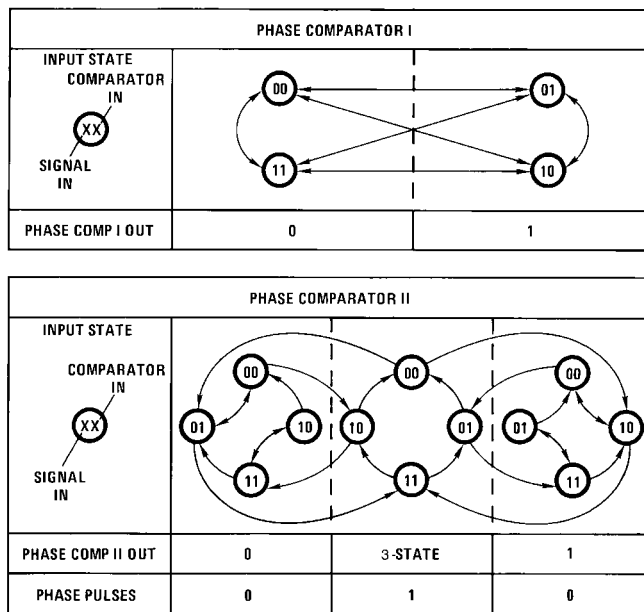

FIGURE 2.

Typical Waveforms

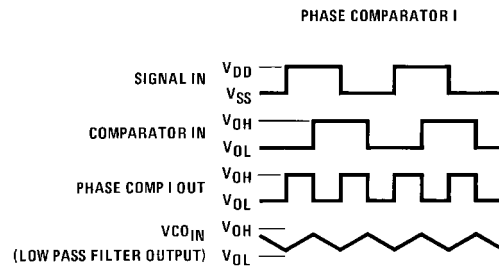

FIGURE 3. Typical Waveform Employing Phase Comparator I in Locked Condition

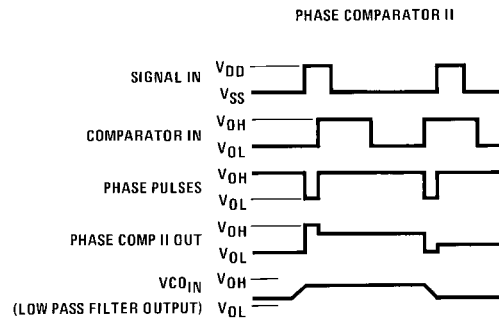

FIGURE 4. Typical Waveform Employing Phase Comparator II in Locked Condition

Typical Performance Characteristics

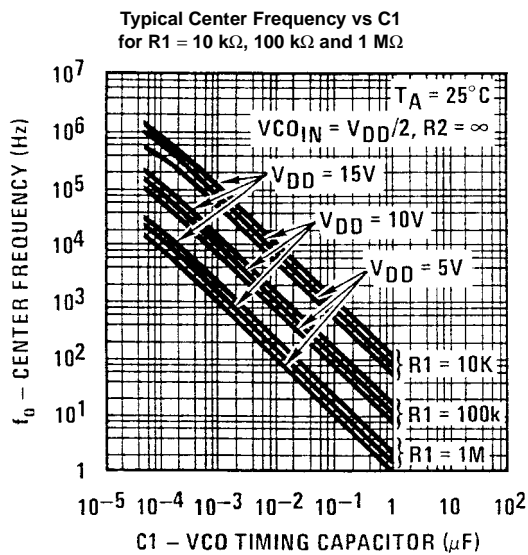

FIGURE 5.

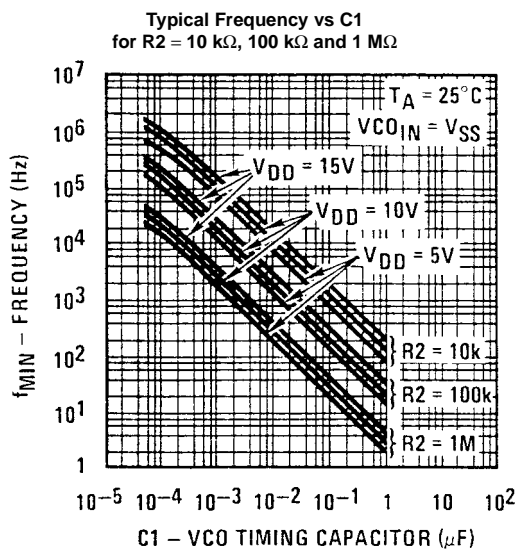

FIGURE 6.

Note: To obtain approximate total power dissipation of PLL system for no-signal input: Phase Comparator I, $P_D (Total) = P_D (f_0) + P_D (f_{MIN}) + P_D (R_S)$; Phase Comparator II, $P_D (Total) = P_D (f_{MIN})$.

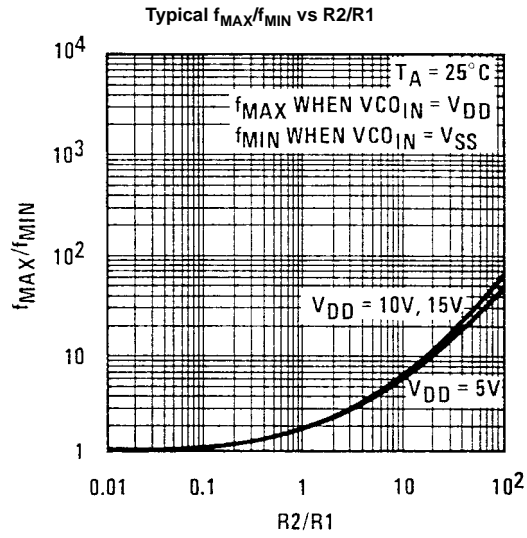

FIGURE 7.

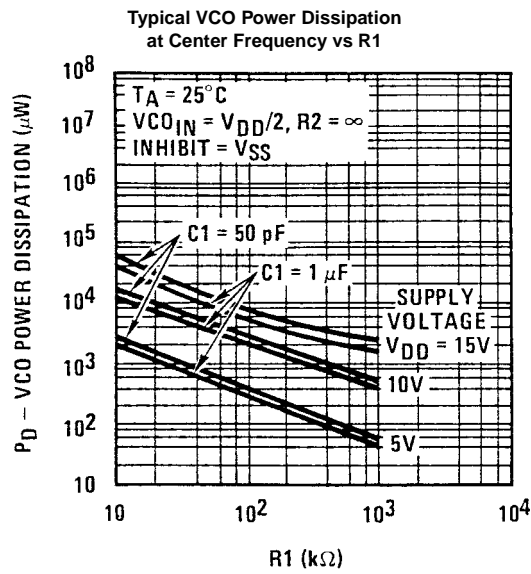

FIGURE 8.

Note: To obtain approximate total power dissipation of PLL system for no-signal input: Phase Comparator I, $P_D (Total) = P_D (f_o) + P_D (f_{MIN}) + P_D (R_S)$; Phase Comparator II, $P_D (Total) = P_D (f_{MIN})$.

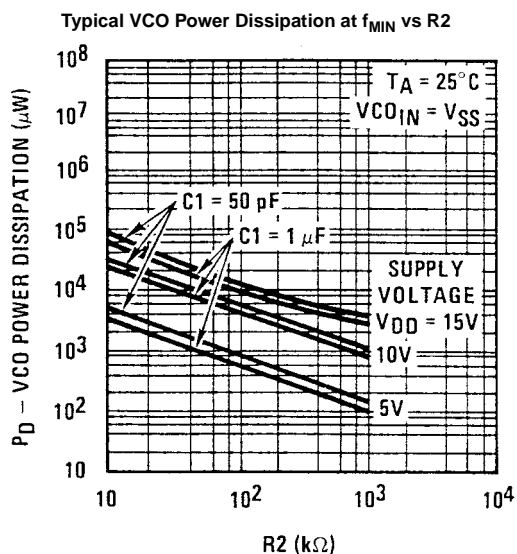

FIGURE 9.

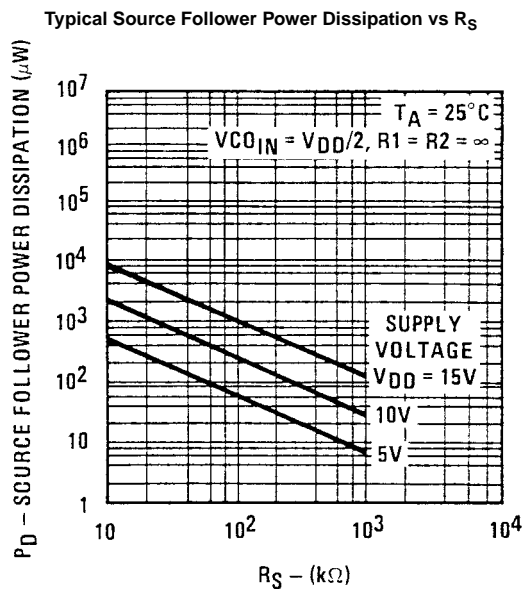

FIGURE 10.

Note: To obtain approximate total power dissipation of PLL system for no-signal input: Phase Comparator I, $P_D(\text{Total}) = P_D(f_0) + P_D(f_{MIN}) + P_D(R_S)$; Phase Comparator II, $P_D(\text{Total}) = P_D(f_{MIN})$.

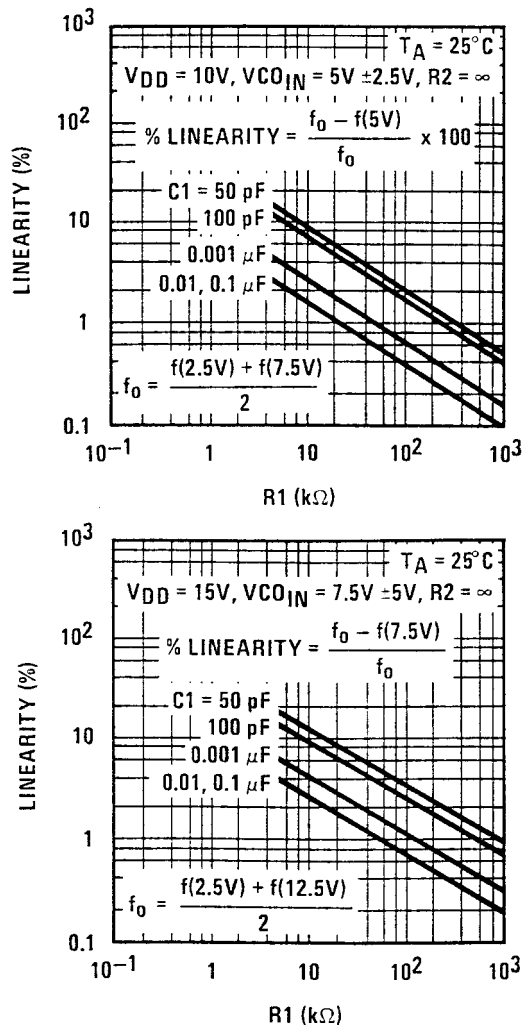

FIGURE 11. Typical VCO Linearity vs R1 and C1

Note: To obtain approximate total power dissipation of PLL system for no-signal input: Phase Comparator I, $P_D(\text{Total}) = P_D(f_0) + P_D(f_{MIN}) + P_D(R_S)$; Phase Comparator II, $P_D(\text{Total}) = P_D(f_{MIN})$.

Design Information

This information is a guide for approximating the value of external components for the CD4046B in a phase-locked-loop system. The selected external components must be within the following ranges: $R_1, R_2 \geq 10 \text{ k}\Omega$, $R_S \geq 10 \text{ k}\Omega$, $C_1 \geq 50 \text{ pF}$.

In addition to the given design information, refer to Figure 5, Figure 6, Figure 7 for R_1, R_2 and C_1 component selections.

| Characteristics | Using Phase Comparator I | | Using Phase Comparator II | |
|---|---|------------------------|---|-----------------|
| | VCO Without Offset $R_2 = \infty$ | VCO With Offset | VCO Without Offset $R_2 = \infty$ | VCO With Offset |
| VCO Frequency | | | | |
| For No Signal Input | VCO in PLL system will adjust to center frequency, f_0 | | VCO in PLL system will adjust to lowest operating frequency, f_{\min} | |
| Frequency Lock Range, $2 f_L$ | $2 f_L = \text{full VCO frequency range}$ $2 f_L = f_{\max} - f_{\min}$ | | | |
| Frequency Capture Range, $2 f_C$ | $2 f_C \approx \frac{1}{\pi} \sqrt{\frac{2 \pi f_L}{\tau_1}}$ | | | |
| Loop Filter Component Selection | | For $2 f_C$, see Ref. | | $f_C = f_L$ |
| Phase Angle Between Single and Comparator | 90° at center frequency (f_0), approximating 0° and 180° at ends of lock range ($2 f_L$) | | Always 0° in lock | |
| Locks on Harmonics of Center Frequency | Yes | | No | |
| Signal Input Noise Rejection | High | | Low | |

| Characteristics | Using Phase Comparator I | | Using Phase Comparator II | |
|-------------------------|---|---|---|--|
| | VCO Without Offset R2 = ∞ | VCO With Offset | VCO Without Offset R2 = ∞ | VCO With Offset |
| VCO Component Selection | <p>Given: f_o.</p> <p>Use f_o with Figure 5 to determine R1 and C1.</p> | <p>Given: f_o and f_L.</p> <p>Calculate f_{min} from the equation</p> $f_{min} = f_o - f_L$ <p>Use f_{min} with Figure 6 to determine R2 and C1.</p> <p>Calculate</p> $\frac{f_{max}}{f_{min}}$ <p>from the equation</p> $\frac{f_{max}}{f_{min}} = \frac{f_o + f_L}{f_o - f_L}$ <p>Use</p> $\frac{f_{max}}{f_{min}}$ <p>with Figure 7 to determine ratio R2/R1 to obtain R1.</p> | <p>Given: f_{max}.</p> <p>Calculate f_o from the equation</p> $f_o = \frac{f_{max}}{2}$ <p>Use f_o with Figure 5 to determine R1 and C1.</p> | <p>Given: f_{min} and f_{max}.</p> <p>Use f_{min} with Figure 6 to determine R2 and C1.</p> <p>Calculate</p> $\frac{f_{max}}{f_{min}}$ <p>Use</p> $\frac{f_{max}}{f_{min}}$ <p>with Figure 7 to determine ratio R2/R1 to obtain R1.</p> |

References

G.S. Moschytz, "Miniaturized RC Filters Using Phase-Locked Loop", BSTJ, May, 1965.
 Floyd Gardner, "Phaselock Techniques", John Wiley & Sons, 1966.

Physical Dimensions inches (millimeters) unless otherwise noted

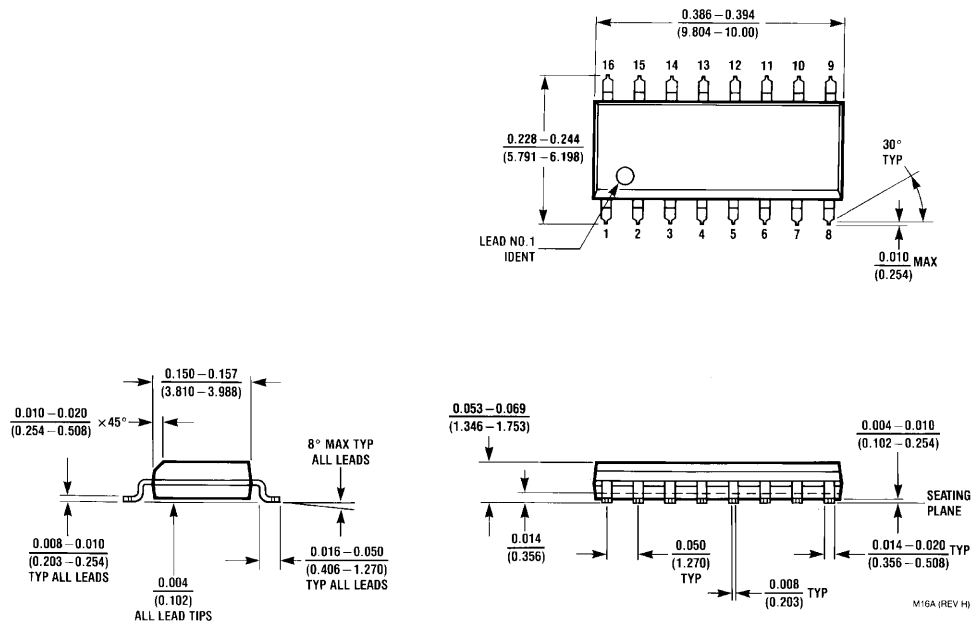

**16-Lead Small Outline Integrated Circuit (SOIC), JEDEC MS-012, 0.150" Narrow Body
Package Number M16A**

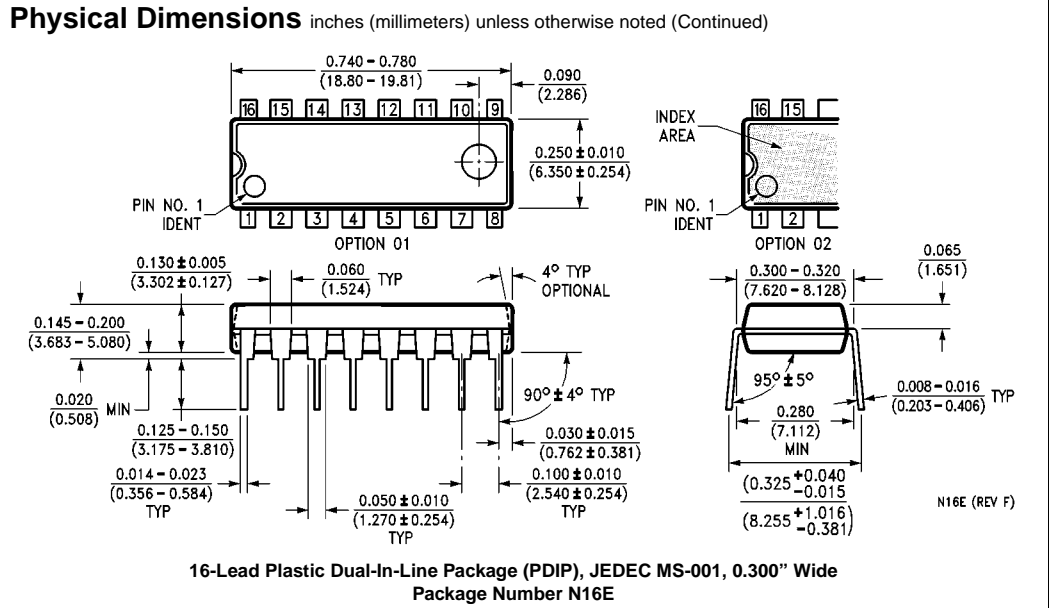

LIFE SUPPORT POLICY

FAIRCHILD'S PRODUCTS ARE NOT AUTHORIZED FOR USE AS CRITICAL COMPONENTS IN LIFE SUPPORT DEVICES OR SYSTEMS WITHOUT THE EXPRESS WRITTEN APPROVAL OF THE PRESIDENT OF FAIRCHILD SEMICONDUCTOR CORPORATION. As used herein:

1. Life support devices or systems are devices or systems which, (a) are intended for surgical implant into the body, or (b) support or sustain life, and (c) whose failure to perform when properly used in accordance with instructions for use provided in the labeling, can be reasonably expected to result in a significant injury to the user.
2. A critical component in any component of a life support device or system whose failure to perform can be reasonably expected to cause the failure of the life support device or system, or to affect its safety or effectiveness.

www.fairchildsemi.com